

Pressure Valves

Series A, indirectly controlled, with check valve and servo valves

Flow rates up to 120 l/min
Operating pressure up to 350 bar



Valve for threaded connection

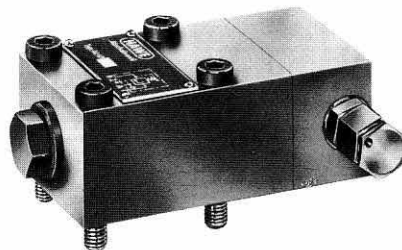
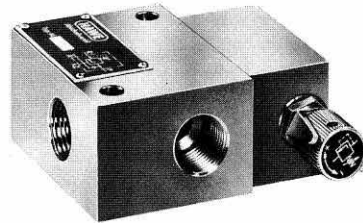

Servo valve

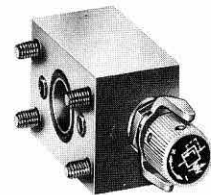

Valve for plate mounting

1. General

The main function of pressure valves is to control the pressure in hydraulic systems (DIN standard 24 300). The following basic functions are obtained for Serie A, depending on the combined action of the valve elements:

- Pressure limiting valves type AS... provide protection against unacceptable peak pressures (safety valves) or limit the working pressure to its maximum permissible value.
- AL... type cut-off valves (idle valves) are used for pump circulation control systems in hydraulic circuits with and without accumulators or for relieving a low-pressure circuit in a two-stage system. If used in single-stage systems, a certain pulsation of the pump oil flow is required for operational reasons to achieve the switch-over jump. Observe the remarks in the middle of Sect. 3.3 or address your questions to HAWE.
- Relief valves type AE... are used for pump rotation control systems with the control pressure being taken from a secondary systems (external-source pressure).
- Dual functions a) + b), a) + c) or b) + c) by combining appropriate servo valves

2. Description

Main valve section

consisting of housing with threaded connections of for base-plate connection, spring-loaded spool in floating, strainfree liner, and check valve at the actuator end. The main valve section (pressure compensator) can only function in conjunction with a servo valve. The passage P → R is either blocked or released, depending on the working position of the servo valve and the resulting pressure difference between the feed end P and the spring chamber.

Servo pressure valve

which opens by system pressure or external pressure depending on the functional design of the active valve elements, and which gives the basic functions listed in Section 1 in connection with the main valve. As an optional feature, it can be supplemented by a 2/2-way solenoid valve in accordance with pamphlet 6540 (note restrictions in Section 4.1) for solenoid-operated circulation connections, and combined with an additional servo pressure valve, resulting in additional basic functions.

Also refer to schematic diagrammatical drawings Section 3.3

3. Available types
3.1. Type code and main data

ASE.4GH/MR-GR 2-0-300/...

Pressure specification in bar (only for factory-adjusted model).
Also see pressure range

Additionally built-on solenoid-operated 2/2-way seated valve for idling connection (for further details also see pamphlet 6540)	Identification	input voltage 1)	Power required	relative duty cycle	protection	electrical state for relief (idling)
1) special voltage upon request	GS 2-0	24 V =	15 W	100% ED	IP 54	de-energised
	GR 2-0					energised
	WS 2-0	220 V ~	14 W		IP 65	de-energised
	WR 2-0					energised
	without	without built-on electrovalve				

ED = Duty cycle

Pressure range	Identification		setting from/to (bar)			admissible servo pressure see item 3.2
	factory-adjust.	variable	Type AS	Type AL	Type AE	
	M	MR	3...200	30...200	3...200	
	H	HR	5...350	40...350	5...300	

Line connection	Identification	connection	Size		
			3	4	5
	G	threaded pipe connection	R 1/2"	R 3/8"	R 1"
	P	plate mounting	for line connection with threaded stem form B DIN 3852		
			corresp. to nominal size 16		corresponds to nominal size 20

Size and maximum flow	Code No.	3	4	5	Δp - Q - characteristic lines see item 3.2
		Flow (l/min)	50	80	

Servo pressure valve	Identification	external connection R 1/4" for	Remarks	
		without	not avail.	normal type
	F	control oil feed connection X	connection X for external relief (idling)	cannot be combined with built-on solenoid-operat. 2/2-way seated valve
	T	control oil drain connection T	Connect. T for non-pressurised draining of control oil when back press. in R	

Valve type

Identification	pressure limiting valve	cut-off valve	external pressure-controlled relief valve	pressure limiting valve and press.-controlled relief valve	cut-off valve and press.-controlled relieve valve
----------------	-------------------------	---------------	---	--	---

Identification	AS	AL	AE	ASE	ALE
----------------	-----------	-----------	-----------	------------	------------

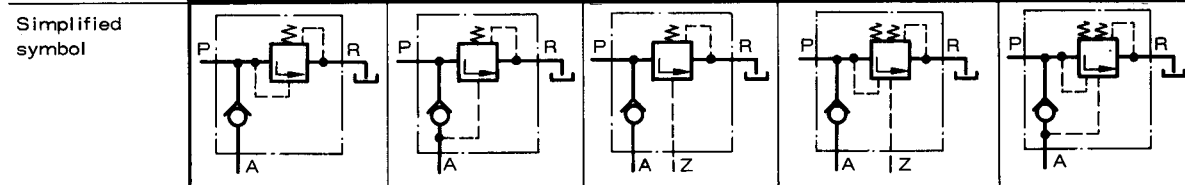

complete presentation of symbols and schematic diagrammatical drawings of all possible variations see item 3.3

Weight (approx. kg)	Size 3	1,8	2,4
	Size 4	2,2 (threaded connection)	1,9 (plate mounting)
Size 5	4,1	4,7	
Notes	with built-on electrovalve additionally 0,4-		

3.2. Additional Characteristics

Description and Schematic diagramme	see Sections 3.1 and 3.3
Construction	spool valve with a downstream ball check valve
Mounting	two throughholes in the housing
Unit dimensions	see Sections 6.1 and 6.2
Orientation	optional, in units with a built-on solenoid, preferably with the solenoid upright
Direction of flow	P → A or P → R
Pressure fluid,	hydraulic oil 9...68 mm ² /s at 40... 50°C
Viscosity range	min. limit approx. 4, max. limit approx. 1500 mm ² /s optimum range approx. 10...500 mm ² /s
Temperatures	oil: -30...+80°C, with type AL as an inherently-controlled cut-off valve -20...+ 80°C ambience: -35...+ 80°C, with a built-on solenoid 100% Duty cycle up to + 40°C 50% Duty cycle up to + 60°C 25% Duty cycle up to + 70°C
Pressure	max. and min. variable pressure dependent on the valve type, see Sect. 3.1 max. pilot pressure 500 bar (static loading capacity of connexions A and Z)
AL as an inherently-controlled cut-off or charging valve	shifting difference: operating position is interrupted when the pressure on consumer side A falls below the set pressure by approx. 20%.

Δp - Characteristics

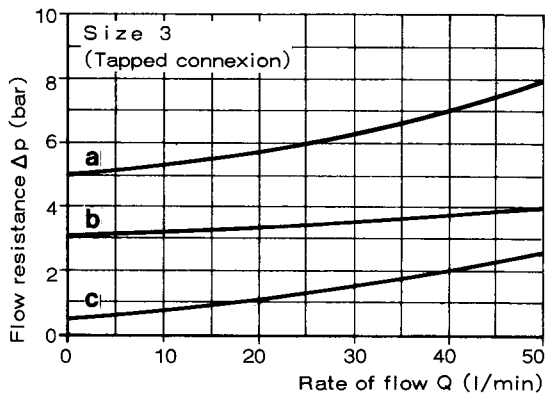

Explanation of the curves:

Direction of flow	Curve	Type
P → R	a	AS ... GH and AS ... PH
	b	AS ... GM and AS ... PM AL ... GM(H) and AL ... PM(H) AE ... GM(H) and AE ... PM(H)
P → A	c	all types

Oil viscosity during measurement = 63 mm²/s

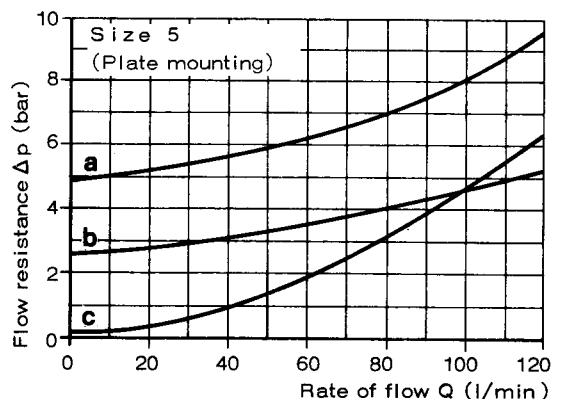
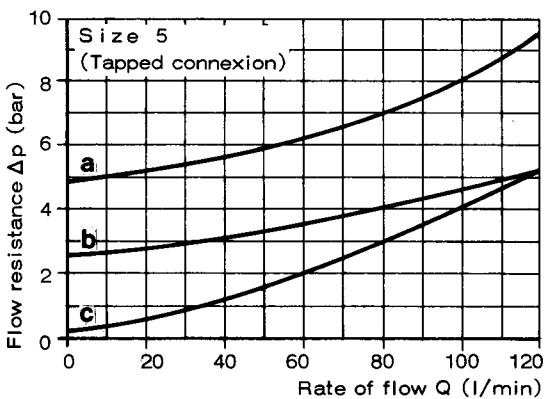
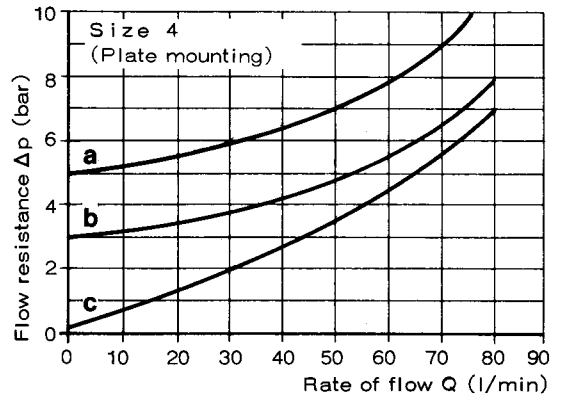
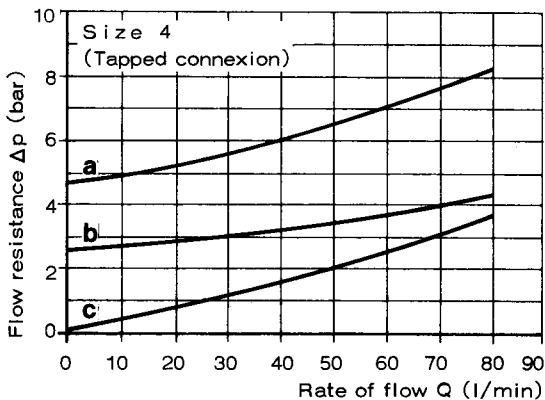

3.3. Diagrammatic representation and symbol

Pressure limiting valve

Used as a pressure limiting valve (system-pressure controlled) type AS..., facility for remote-controlled relief (idling connection) for type ASF... by pressure relieving the remote-control connection X, for type AS...G.2-0 by means of electrical signal to the built-on 2/2-way valve. Type AST... for external, non-pressurised control oil draining via the connection X, if a back-pressure at R is not to affect the pressure valve.

When it is used as an auxiliary valve the control oil flow via T is between 0,7 l/min and 7 l/min, depending on the difference between actuator pressure at R and the auxiliary pressure P (see Example 2 in Section 5.1)

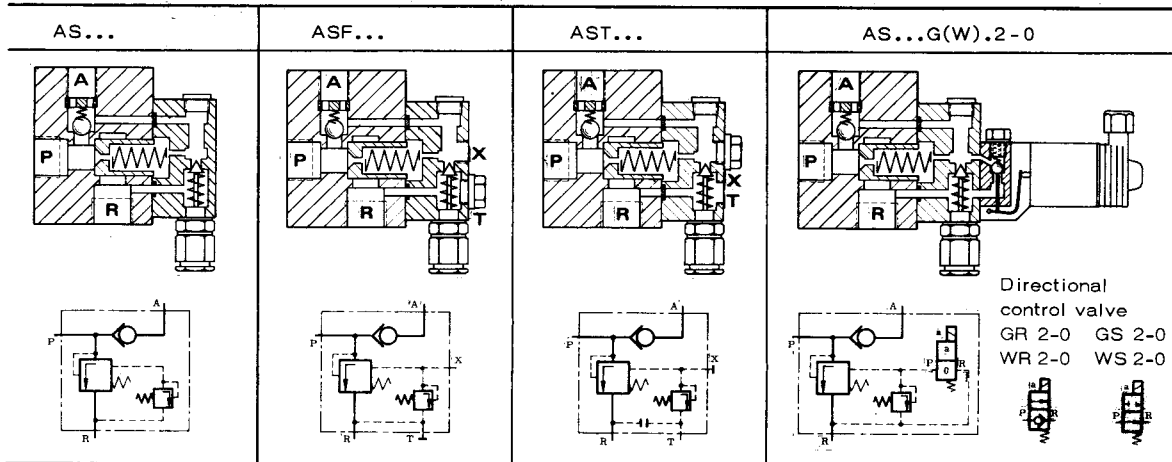

Cut off-valve

Can be used as a pressure limiting valve (inherently controlled) and as a cut-off valve. Conditions for use: when the LA valve is used as a cut-off valve (for pump circulation) in single-stage systems, a certain pressure pulsation is required to achieve the switch-over jump. The valve must therefore be placed as close to the pump as possible in accumulator charging control systems; the same applies as well to low-pulsation pumps (internally toothed gear pumps, vane pumps). In circulation control systems without accumulators, the consumer volume including the line attached to connection A should amount to at least 1000 cm³. Conduct a trial run to check to see that the system is functioning properly. Additional idling connection by pressure relieving via the remote-control connection X for type ALF or electrically for type AL...G.2-0. Type ALT... for external, non-pressurised oil draining via connection T, if a back-pressure at R is not to affect the pressure set value.

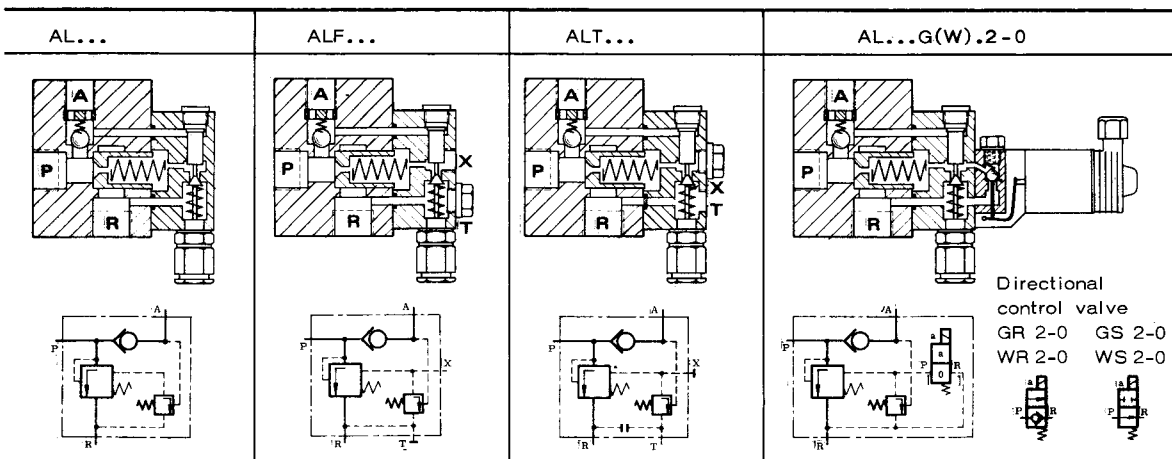

Pressure-controlled relief valve with external-pressure control oil connection Z

Used as a straight relief valve (external-pressure controlled), type AE. Passage P → R = closed if the control pressure at Z is less than the pressure set value, P → R = free if the control pressure at Z is higher than the pressure set value. Additional relief connection by pressure relieving via the remote-control connection X for type AEF... or electrically for type AET...G.2-0. Type AET... for external, non-pressurised control oil draining via connection T if a back-pressure at R is not to affect the pressure set value.

Note: The types AE... do not constitute pressure limiting valves, the pressure protection of the pump must be provided separately.

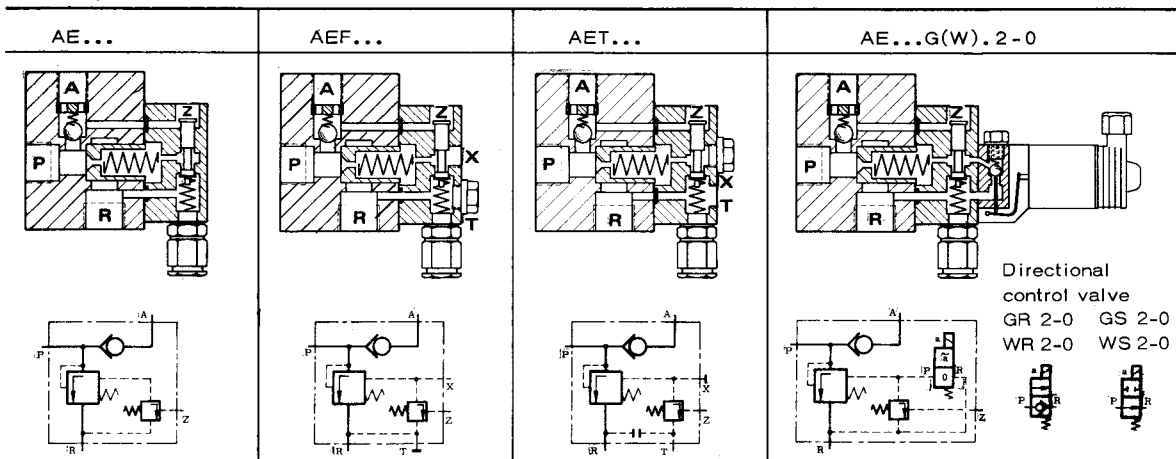

Pressure limiting valve with pressure-controlled relief valve

The modes of operation of the basic valves types AS... and AE... add up as described on Sheet 4. The optional connections X or T are always located at the outer servo valve with the connection Z. The optionally built 2/2-way solenoid on valve is fitted at the side of the inner servo valve following the main valve

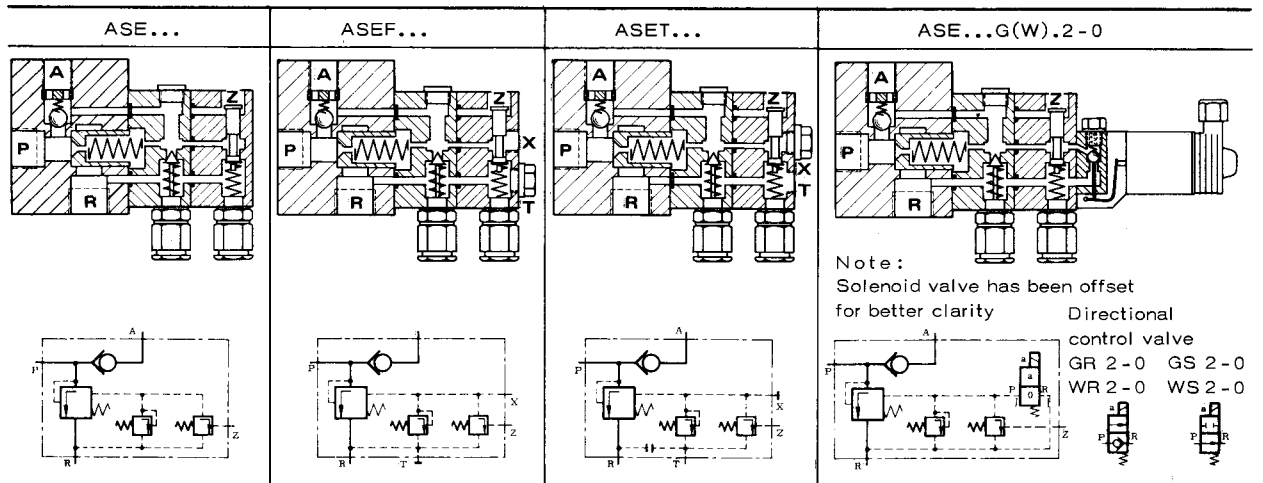

Cut-off valve with pressure-controlled relief valve

The modes of the operation of the basic valves types AL... and AE... add up as described on Sheet 4. The optional connections X or T are always located at the outer servo valve with the connection Z. The optionally built 2/2-way solenoid valve is fitted at the side of the inner servo valve following the main valve

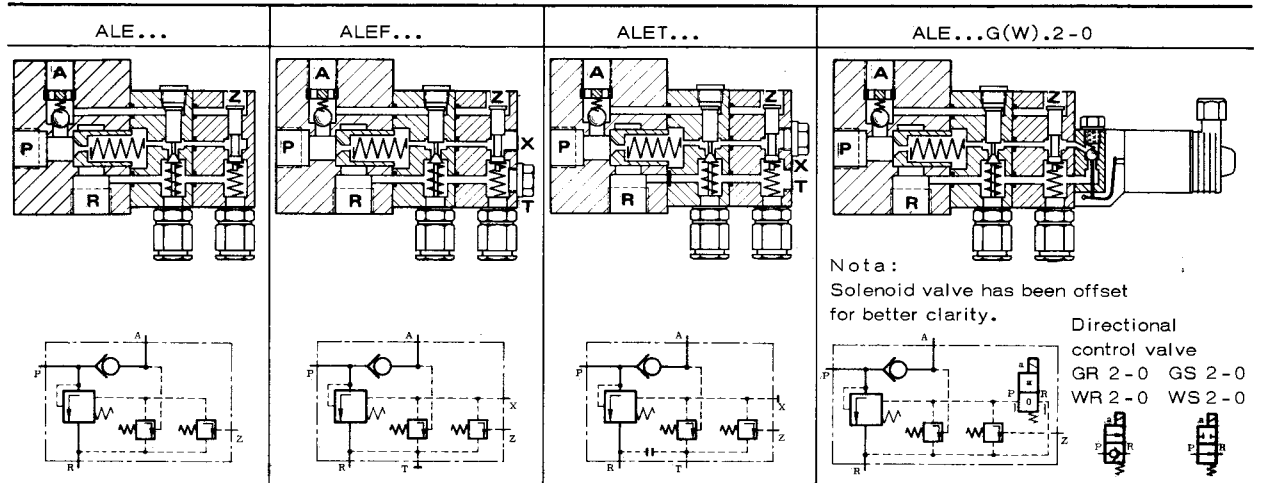

3.3.1. Simplified symbols in accord. with DIN standard 24 300 for general use in circuit diagrams
If the operating function is required to be clearly distinguishable, then the detailed represent. in Sect.3.3 must be used.

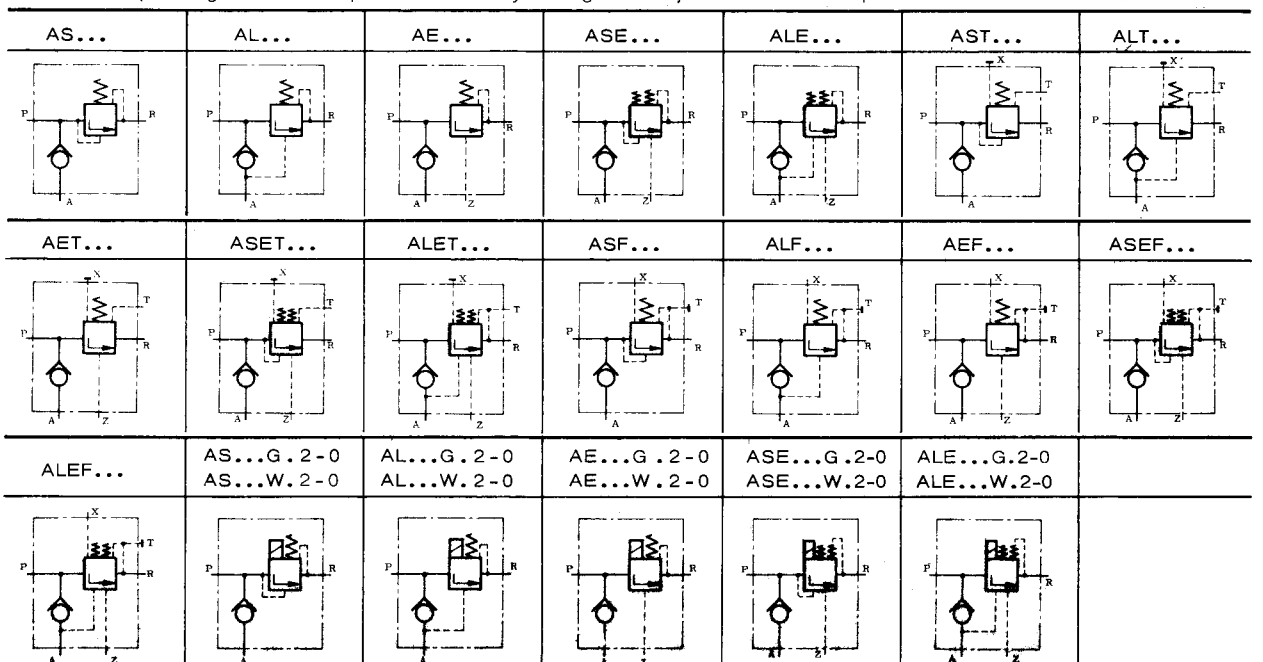

4. Available Pilot Valve Designs

Pilot valves can be employed only for inherent or external pressure control of spring-loaded variable valves such as the main valve in Sect.3. The D 1P... and A 1P... types are not suitable as pressure limiting valves to safeguard oil systems because their flow characteristics are not designed for such use (see Sect.4.2). Valves such as those in pamphlet D 3726 must be used in such cases. The E 1P... type can be used in principle for the externally controlled relief of optional oil control systems up to approx. 4l/min. Refer to the $\Delta p - Q$ characteristic in Section 4.2. The same applies to the A 1P type.

4.1. Type Code and Main Data

D1PH-WS2-0-250

Pressure specification in bar (only for factory-adjusted model) Also see pressure range	2/2-way valve for solenoid-controllable relief functions		only possible for size D and A, not E and ... F, ... T. Data see item 3.1!		
	Pressure range		Identification factory-adjusted	variable	Setting from - to (bar) Type D.. Type A.. Type E..
Size and Connection	Size		Connection		admissible servo pressures mentioned below
	Code Number	Flow	Identif.		
	1	4 l/min	P	Plate mounting	
Design and Nomenclature	Seat-type valve			Piston valve	
	press. limiting valve	press. limiting valve and relief valve with control pressure connection Z		relief valve with ext. control pressure connection Z	
Identification	normal	D	A	E	
	ext. secondary press. connect. X	DF	AF	EF	
	ext. tank connection T	DT	AT	ET	
	double servo valve	D(A)1P.../E 1P D(A)1P.../EF 1P D(A)1P.../ET 1P		the valves D and A can be combined to double valves with E, EF and ET	
1) as far as possible with solenoid valve + 0,4 kg				Weight 1) approx. kg	

4.2. Additional Characteristic Values

- Mounting by four M6 x 35(65) DIN 912
- Dimensions of units see item 6.3
- Installed position as desired
- Flow direction only P → R
- Pressure fluid see item 3.2
- Temperatures see item 3.2
- $\Delta p - Q$ - characteristics characteristic as pressure limiting valve
Type D and A (not discharged)

Flow resistance for type A and E in discharged condition (control pressure on Z)

Oil viscosity during test 63 mm²/s
Attention: + 15 and + 18 bar only recommended values!

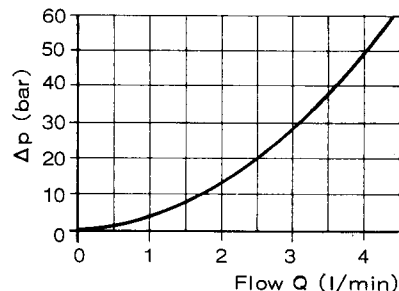
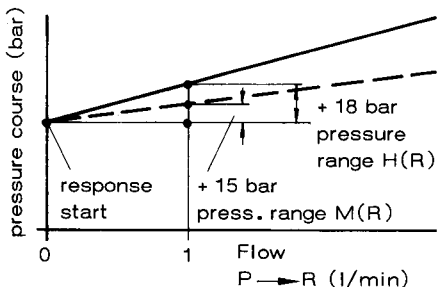

4.3. Diagrammatical representation and symbol

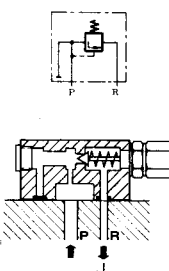
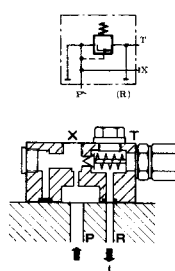
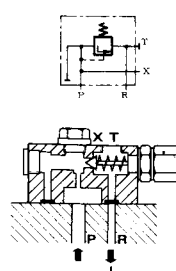
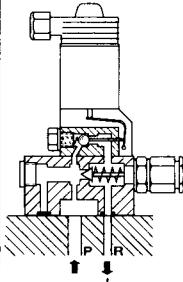
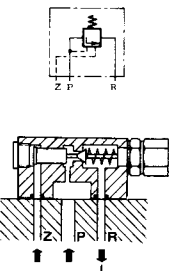
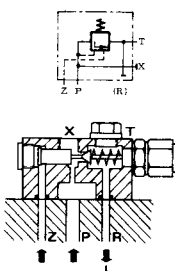
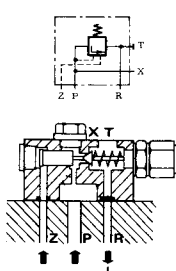
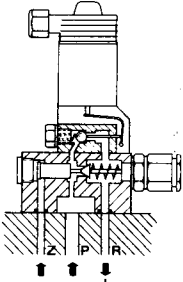
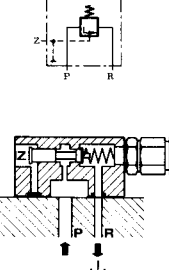
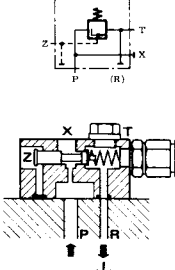
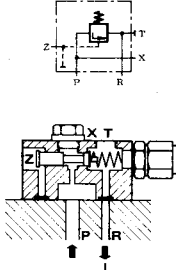
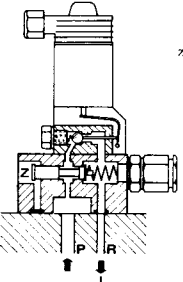
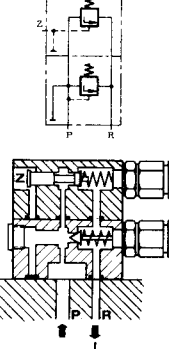
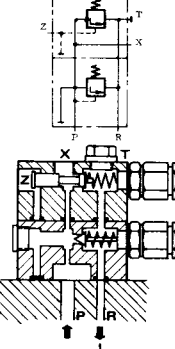
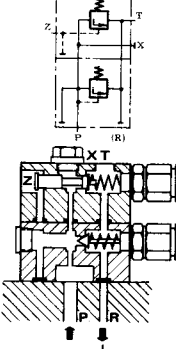
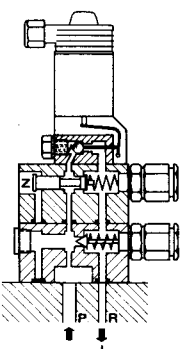
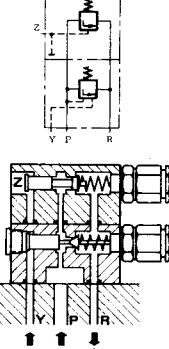
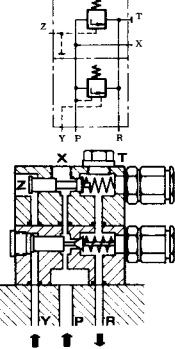
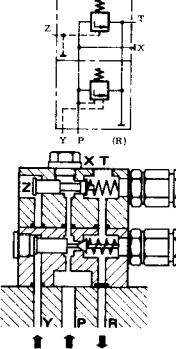
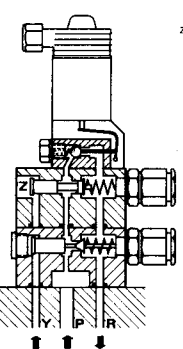
<p>For use as pressure limiting valve</p> <p>It functions as a pressure limiting valve, but can only be used as a servo valve for controllable, spring-loaded poppet or piston valves according to the main valve type shown in Section 3. For general pressure protection see the equipment shown in leaflet 3726. Relief facility by electrical signal for type ...-G(W).2-0</p>	<p>D 1P...</p> 	<p>DF 1P...</p> 	<p>DT 1P...</p> 	<p>D 1P...G(W).2-0</p>  <p>Directional control valve GR 2-0 WR 2-0 GS 2-0 WS 2-0</p>
<p>For use as pressure limiting and relief valve (cut-off valve)</p> <p>It functions as a pressure limiting valve, with relief facility by control pressure at Z. It serves to pilot-control spring loaded poppet and piston valves according to the main valve type shown in Section 3. Additional relief facility by electrical signal for type ...-G(W).2-0</p>	<p>A 1P...</p> 	<p>AF 1P...</p> 	<p>AT 1P...</p> 	<p>A 1P...G(W).2-0</p>  <p>Directional control valve GR 2-0 WR 2-0 GS 2-0 WS 2-0</p>
<p>For use as relief valve</p> <p>It functions as a relief valve. Relief is effected by control pressure at Z. No function as a pressure limiting valve. Pressure protection of a control oil circuit e.g. by using valves according to leaflet 3726. Additional relief facility by electrical signal for type ...-G(W).2-0</p>	<p>E 1P...</p> 	<p>EF 1P...</p> 	<p>ET 1P...</p> 	<p>E 1P...G(W).2-0</p>  <p>Directional control valve GR 2-0 WR 2-0 GS 2-0 WS 2-0</p>
<p>For use as pressure limiting and relief valve</p> <p>It combines the functions of a pressure limiting valve (D 1P...) and relief valve by means of the control pressure (E...), see also data on single valves. Additional relief facility by electrical signal for type ...-G(W).2-0/... In the diagrammatical representation of type ...-G(W).2-0/... the solenoid valve has been offset for better clarity. For specified position see symbol.</p>	<p>D 1P.../E 1P...</p> 	<p>D 1P.../EF 1P...</p> 	<p>D 1P.../ET 1P...</p> 	<p>D 1P...G(W).2-0/E 1P...</p>  <p>Directional control valve GR 2-0 WR 2-0 GS 2-0 WS 2-0</p>
<p>For use as press. limiting cut-off and relief valve</p> <p>It combines the functions of a pressure limiting valve (A 1P...) that can be relieved by the control pressure, and a relief valve (E..) that can be released by a second control pressure. Additional relief facility by electrical signal for type ...-G(W).2-0/... In the diagrammatical representation of type ...-G(W).2-0/... the solenoid valve has been offset for better clarity. For specified position see symbol.</p>	<p>A 1P.../E 1P...</p> 	<p>A 1P.../EF 1P...</p> 	<p>A 1P.../ET 1P...</p> 	<p>A 1P...G(W).2-0/E 1P...</p>  <p>Directional control valve GR 2-0 WR 2-0 GS 2-0 WS 2-0</p>

5. Exemplary Circuits
Indirectly controlled pressure valves
Pressure limiting valves type AS...

Directional valve, actuator

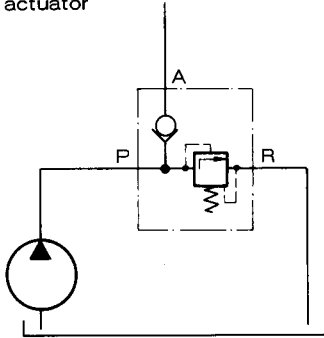

Pressure protection of pump, check valve prevents reaction of actuator back-pressure on the (e.g. switched-off) pump or the pressure limiting valve

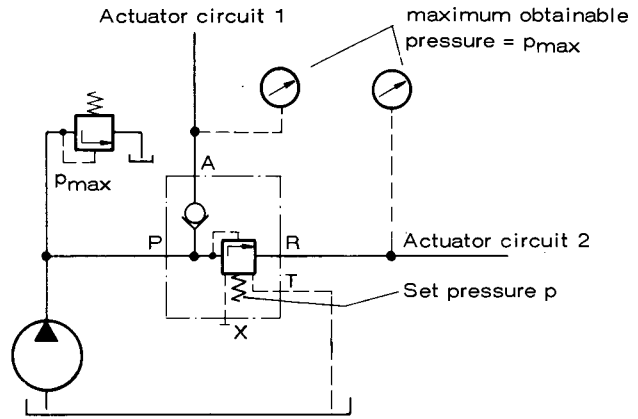

Use as an AST... as pressure sequence or auxiliary valve. Actuator circuit 2 receives pressure oil only if the set pressure is exceeded, control oil flow draining via T between 0,7 l/min in below 10 bar and 7 l/min at approx. 350 bar depending on pressure setting p against actuator pressure at R.

Cut-off valve (idle valve) type AL...

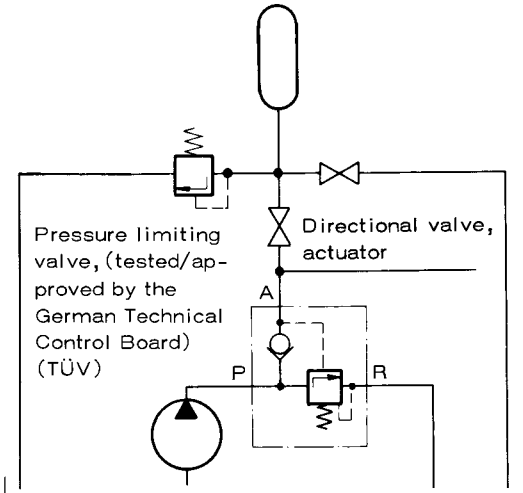

Use as an Accumulator Valve
When used as an accumulator valve, factors inherent in the system (pressure magnitude, accumulator size, type and size of pump) play a special role.
Discuss your operations planning with our consulting engineers.

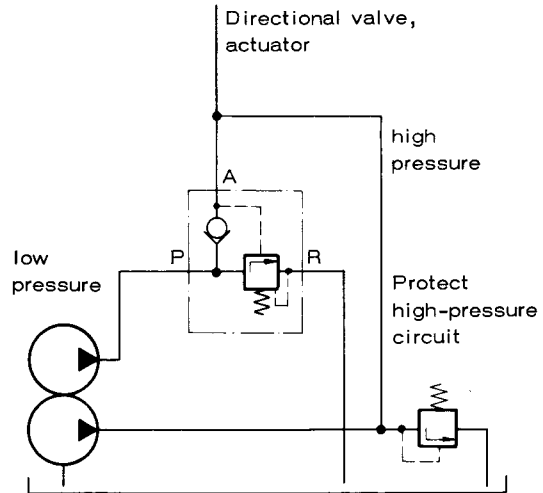

Use as a cut-off valve for the low-pressure oil flow in a two stage circuit when the set pressure value is exceeded, the high-pressure oil flow must be protected separately.

Relief valve type AE...

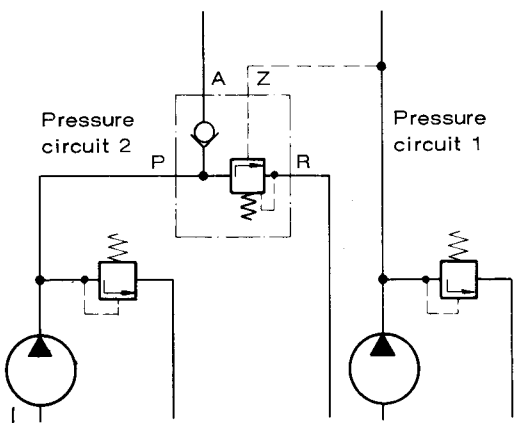

Pressure circuit 2 is bypassed, irrespective of its pressure setting, if the relief pressure value is reached or exceeded in pressure circuit 1

6. Dimensions of Units All dimensions are in millimetres. Subject to change without notice!
 6.1. Pressure valve with threaded connections

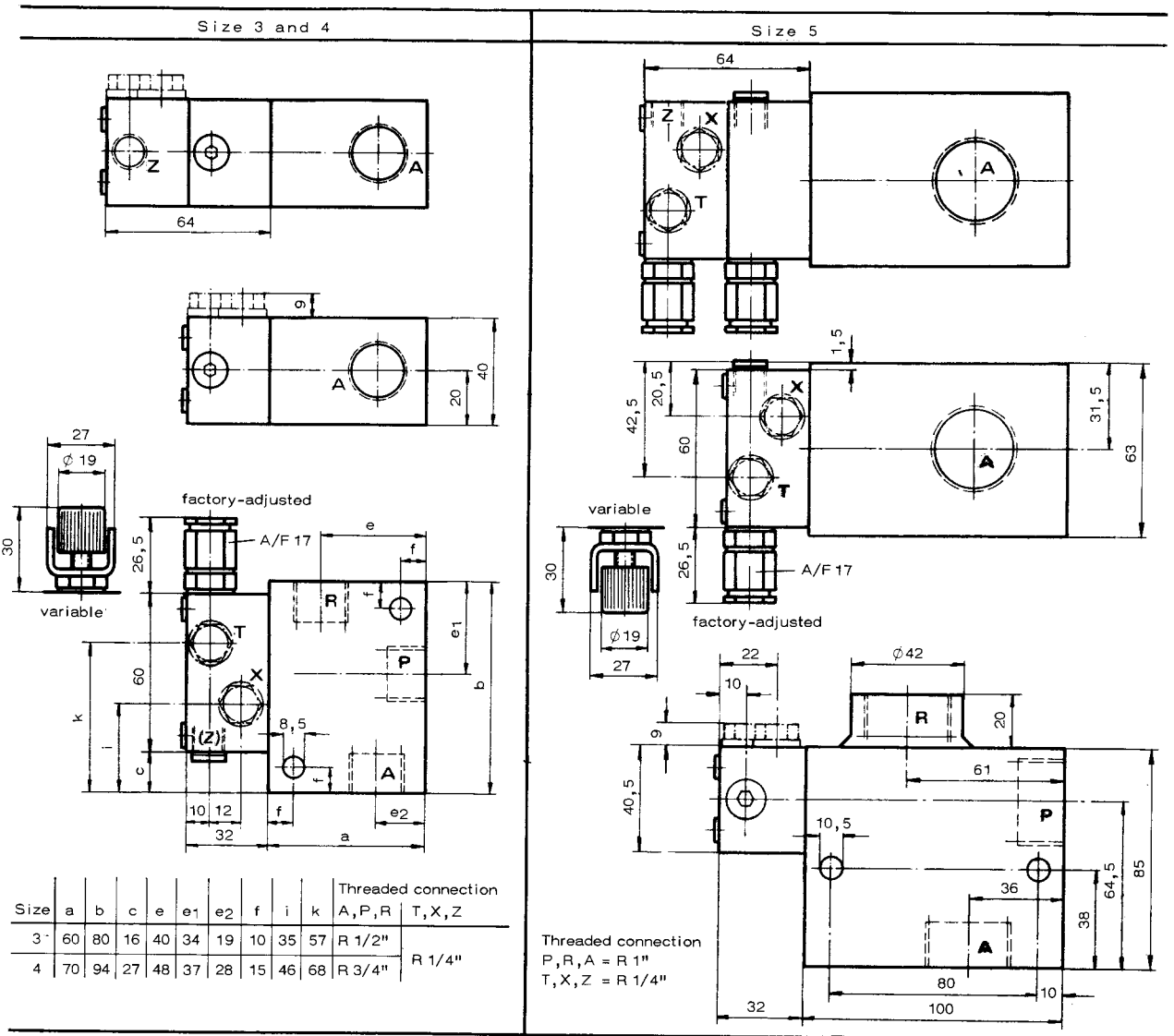

Model with built-on directional seated valve according to pamphlet 6540

Direct current model (G.2-0)

Alternating current model (W.2-0)

plug can be fitted rotated through 180° suitable for 6 φ cable

M3, 6 deep for manual emergency operation

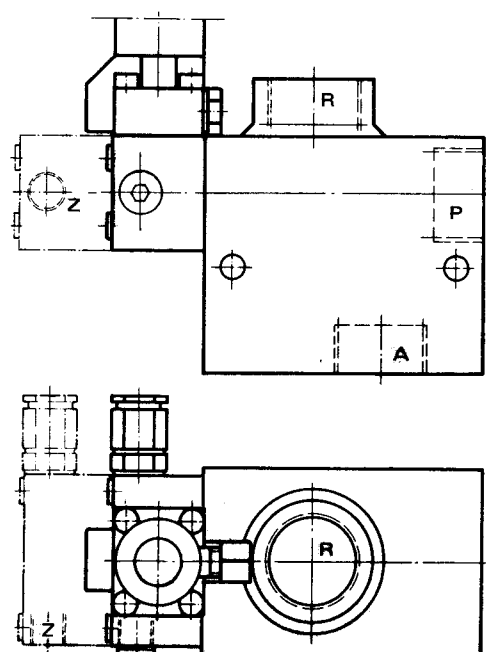
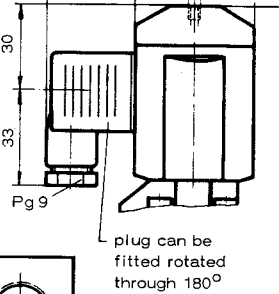
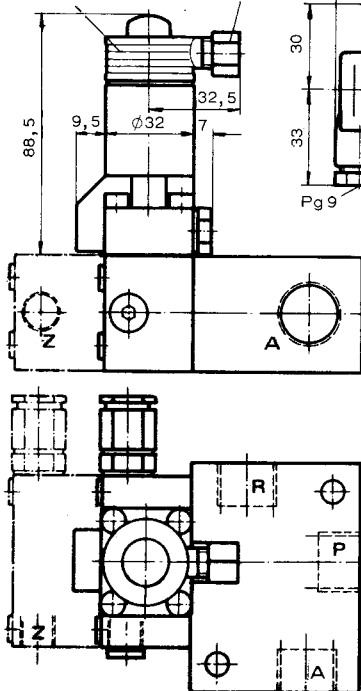

6.2. Pressure valves for plate mounting

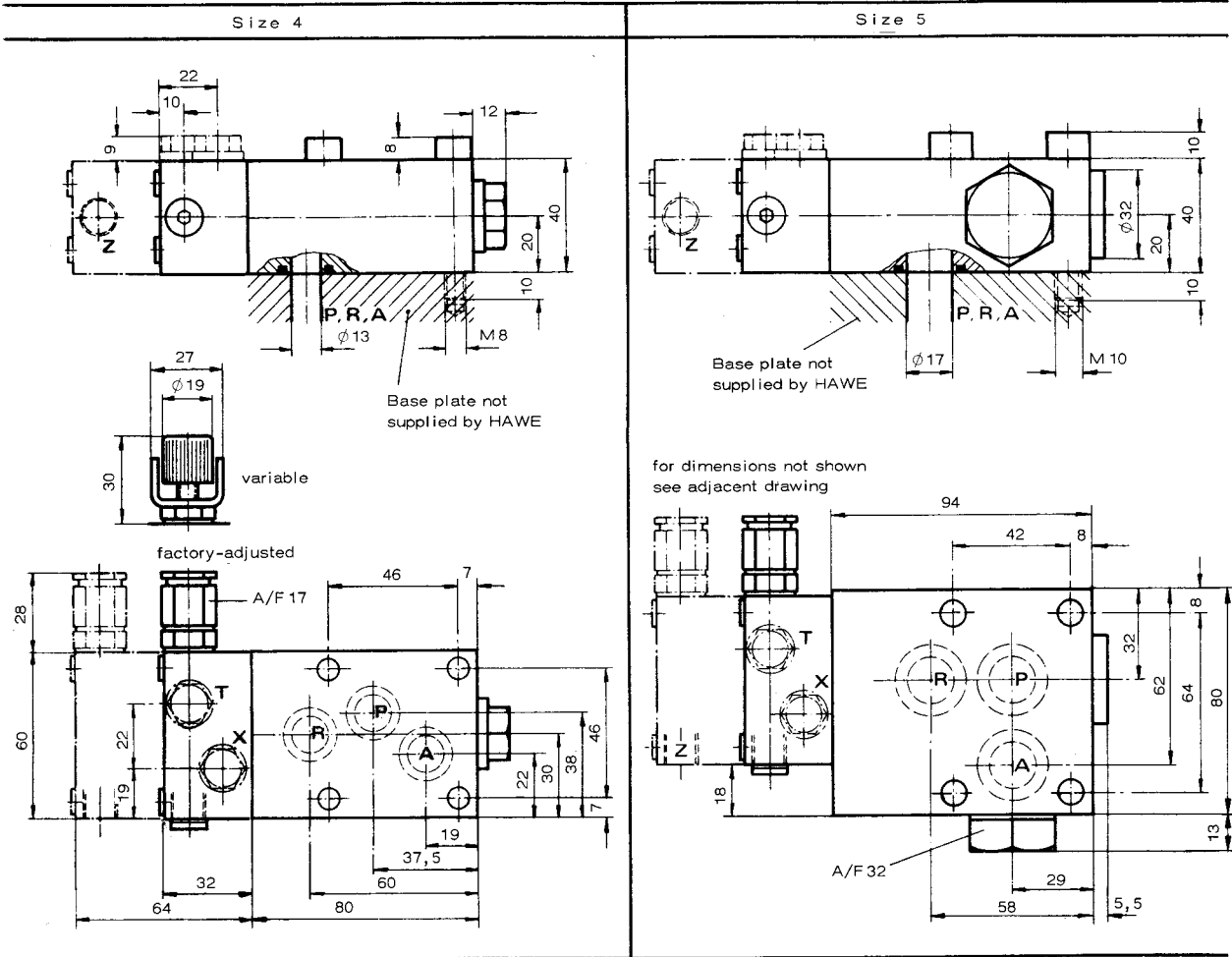

Model with built-on solenoid operated directional seated valve according to pamphlet 6540

Direct current model (G.2-0)

Alternating current model (W.2-0)

plug can be fitted rotated through 180°

suitable for Ø6 cable

M3, 6 deep for manual emergency operation

for dimensions not shown see adjacent drawing

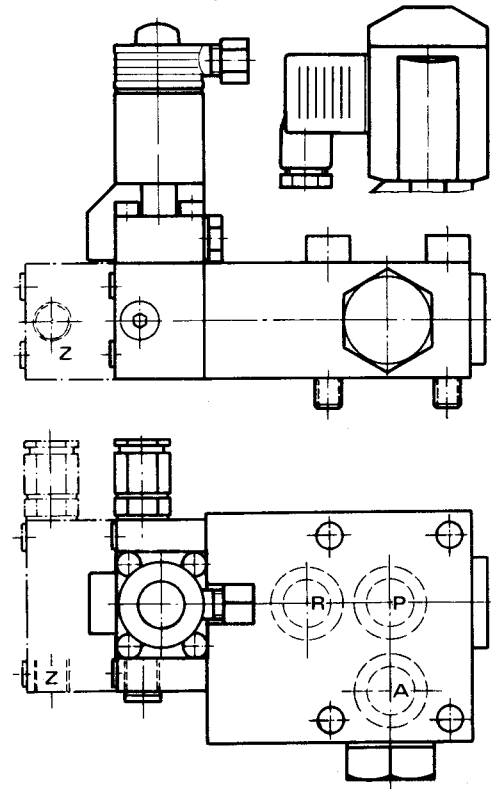
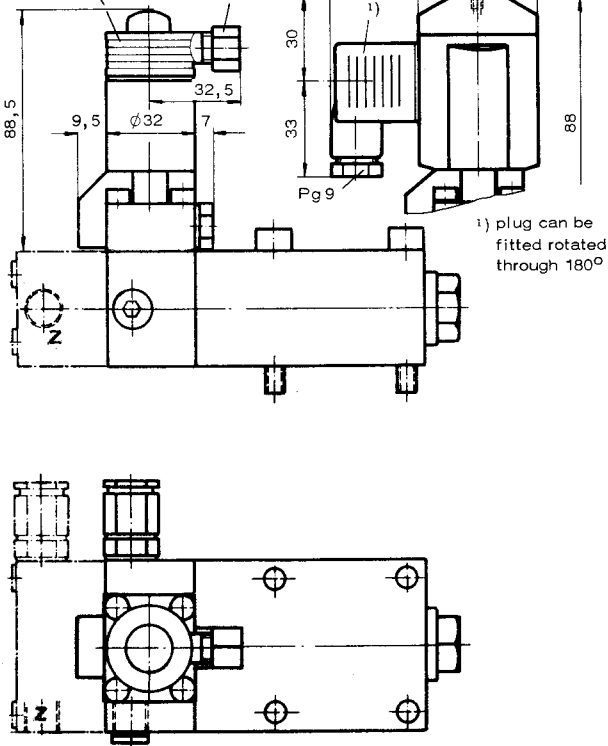

6.3. Servo valves

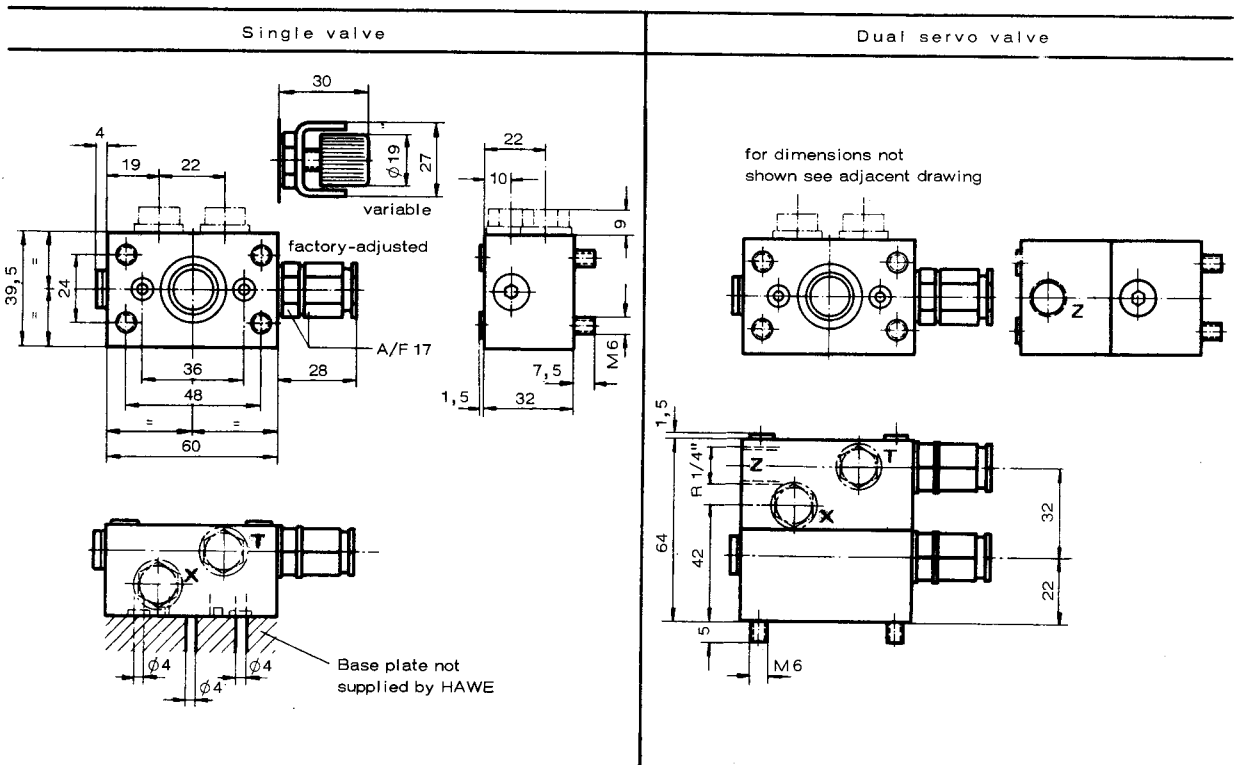

Model with built-on solenoid operated directional seated valve according to pamphlet 6540

