

Directional spool valve type NSWP 2

Manifold mounting valve with connection hole pattern conforming DIN 24 340 - A 6 (NG 6)

Operation pressure p_{max} = 315 bar
 Flow Q_{max} = 25 lpm

See also:

- | | | |
|-----------------------------|--------------|----------|
| ● Directional spool valve | type SW 2 | D 7451 |
| ● Directional valve bank | type SWR 2 | D 7451 |
| ● Directional valve bank | type SWS 2 | D 7951 |
| ● Clamping modules | type NSMD 2 | D 7787 |
| ● Directional seated valves | type NG etc. | D 7300 N |
| ● Directional seated valves | type NBVP 16 | D 7765 N |
| ● Valve banks | type BA 2 | D 7788 |
| ● Intermediate plates | type NZP | D 7788 Z |

Order example:

NSWP 2 G/M/R/ABR1,0 BBR0,8/50/S-G 24

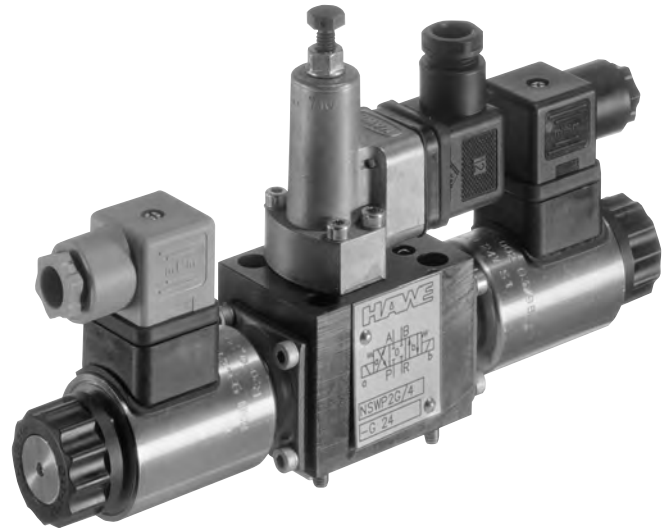
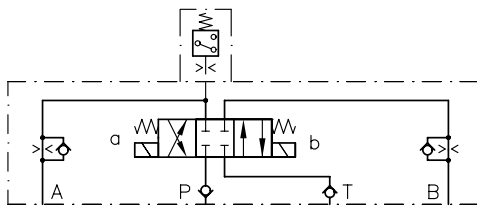

1. General information

Type NSWP 2 was developed as addition to the other already available directional spool valves type SW 2, SWP 2, SWR 2 acc. to D 7451, and SWS 2 acc. to D 7951.

Special features:

- Industrial standard connection hole pattern
- Directly mounted pressure switch monitoring the consumer port
- Various actuation solenoid versions
- Rapid traverse-creeping circuitry
- Differing flow ratings of the spools for the for proportional or throttle spool versions
- Optional elements in the pump, consumer, and return port
- Individual connection block for direct pipe connection

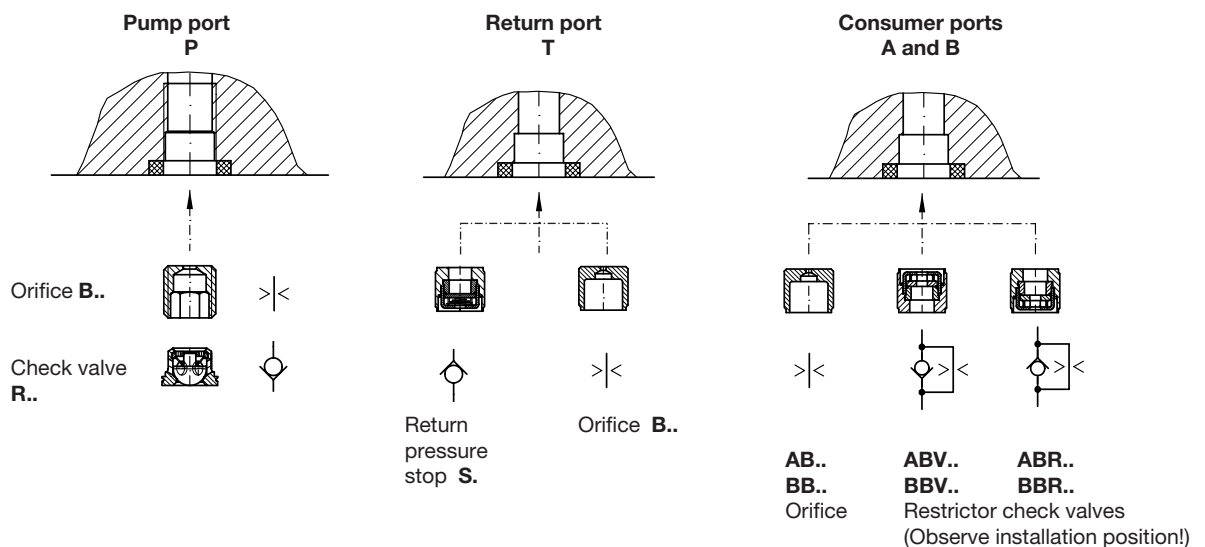

2. Available versions, main data

Order example 1
 Order example 2
 Order example 3

NSWP 2 W/M/20 - WG 230 ¹⁾
NSWP 2 D 06/MP /R/ABR 1,0/20 /S - G 24
NSWP 2 G /MM66/R /50 /B 1,0 - G 24 - 3/8

Order example 1

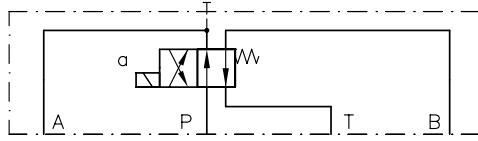

Order example 2

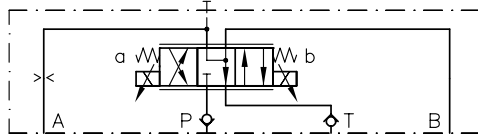

Order example 3

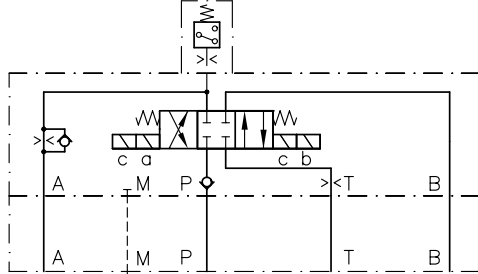

Individual connection block for direct pipe connection

Actuation solenoid (see table 8)

Additional elements at port T (see table 7)

Pressure switch or pressure gauge (see table 6)

Additional elements for ports A and/or B (see table 5)

Additional elements at port P (see table 4)

Solenoid version (see table 3)

Table 1: Basic type

Coding, description	Flow Q _{max} (lpm)	Pressure p _{max} (bar)
NSWP 2 With industrial standard hole pattern DIN 24 340-A 6	25	315

Table 2: Symbols

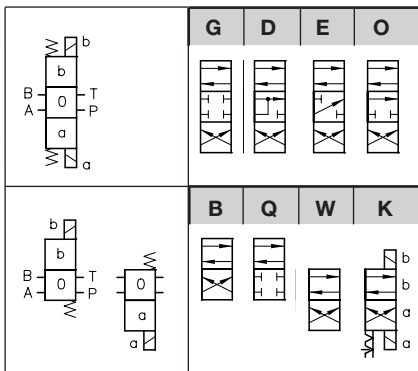

Table 2 a: Flow

Actuation (table 3)	/M /MM..	/MP, /MPF, /MK and /MD ³⁾			
Coding	no coding	03	06	12	20
Q _{max} (lpm)	---	3	6	12	20

Table 3: Solenoid version

Coding	Description																								
/M	On/off solenoid																								
/MK	On/off solenoid with stroke limitation for A and B (Wing screw with lock nut) ^{2) 3)}																								
/MD	On/off solenoid with stroke limitation (knob) for A and B ^{2) 3)}																								
/MP	Proportional solenoid ^{2) 3)}																								
/MPF	Prop. solenoid with stroke limitation ^{2) 3)}																								
/MM...	Double solenoid for rapid traverse / creeping circuitry at A and B ^{2) 4)}																								
	Throttle for 2. speed rate																								
	<table border="1"> <thead> <tr> <th>4</th> <th>5</th> <th>6</th> <th>7</th> <th>8</th> <th>9</th> <th>1</th> <th>2</th> </tr> </thead> <tbody> <tr> <td colspan="8" style="text-align: center;">∅ (mm)</td> </tr> <tr> <td>0.4</td> <td>0.5</td> <td>0.6</td> <td>0.7</td> <td>0.8</td> <td>0.9</td> <td>1.0</td> <td>1.2</td> </tr> </tbody> </table>	4	5	6	7	8	9	1	2	∅ (mm)								0.4	0.5	0.6	0.7	0.8	0.9	1.0	1.2
4	5	6	7	8	9	1	2																		
∅ (mm)																									
0.4	0.5	0.6	0.7	0.8	0.9	1.0	1.2																		
Symbols																									
/M	/MK	/MD	/MP	/MPF	/MM..																				

1) Example for simplified coding, for versions without additional elements
 2) Version with ex-proof solenoid only with solenoid actuation coding **/M**
 3) Available only for symbols G, D, E, and O
 4) Specification is required for both sides, e.g. **/MM67**, for additional info see sect. 5.1

Table 4: Additional elements at port P



Additional element (also in combination)	Coding ¹⁾	Ø (mm)
without	---	---
Orifice 	B 0,4	0.4
	B 0,5	0.5
	B 0,6	0.6
	B 0,7	0.7
	B 0,8	0.8
	B 0,9	0.9
	B 1,0	1.0
	B 1,1	1.1
	B 1,2	1.2
	B 1,4	1.4
	B 1,5	1.5
	B 1,8	1.8
	B 2,0	2.0
	B 2,4	2.4
B 2,5	2.5	
B 3,0	3.0	
B 3,5	3.5	
B 4,0	4.0	
Check valve 	R	---

Table 5: Additional elements for ports A and/or B



Additional element	Coding ^{1) 2)}		Ø (mm)	
	at port A	at port B		
Orifice in A and/or B 	AB 0,3	BB 0,3	0.3	
	AB 0,4	BB 0,4	0.4	
	AB 0,5	BB 0,5	0.5	
	AB 0,6	BB 0,6	0.6	
	AB 0,7	BB 0,7	0.7	
	AB 0,8	BB 0,8	0.8	
	AB 0,9	BB 0,9	0.9	
	AB 1,0	BB 1,0	1.0	
	AB 1,2	BB 1,2	1.2	
	AB 1,5	BB 1,5	1.5	
	AB 2,0	BB 2,0	2.0	
	AB 2,5	BB 2,5	2.5	
	Restrictor check valve at A and/or B throttling in direction to the consumer 	ABV 0,6	BBV 0,6	0,6
		ABV 0,7	BBV 0,7	0,7
ABV 0,8		BBV 0,8	0,8	
ABV 0,9		BBV 0,9	0,9	
ABV 1,0		BBV 1,0	1,0	
ABV 1,2		BBV 1,2	1,2	
ABV 1,5		BBV 1,5	1,5	
ABV 2,0		BBV 2,0	2,0	
Restrictor check valve at A and/or B unthrottled flow to the consumer 	ABR 0,6	BBR 0,6	0,6	
	ABR 0,7	BBR 0,7	0,7	
	ABR 0,8	BBR 0,8	0,8	
	ABR 0,9	BBR 0,9	0,9	
	ABR 1,0	BBR 1,0	1,0	
	ABR 1,2	BBR 1,2	1,2	
	ABR 1,5	BBR 1,5	1,5	
	ABR 2,0	BBR 2,0	2,0	

Table 6: Pressure switch or pressure gauge at port A or B

Pressure switch acc. to D 5440 (adjustable range)	at port A	at port B
without DG (prepared for retrofitting)	20	02
DG 33 (200 ... 700 bar)	30	03
DG 34 (100 ... 400 bar)	40	04
DG 35 (20 ... 250 bar)	50	05
DG 36 (4 ... 12 bar)	60	06
DG 365 (12 ... 170 bar)	70	07
DG 364 (4 ... 50 bar)	80	08
Pressure gauge acc. to D 7077 with scale up to	(mounting via adaptor Y9)	
100 bar	A9/100	B9/100
160 bar	A9/160	B9/160
250 bar	A9/250	B9/250
400 bar	A9/400	B9/400

Table 7: Additional elements at port T



Additional element	Coding	Open-up pressure
without	---	
Return pressure stop (check valve) 	S	approx. 0.07 bar
	S 0,2	approx. 0.2 bar
	S 1	approx. 1.5 bar
Orifice 	B 0,7 .. B 2,5	see coding AB.. resp. BB.. in table 5

Table 8: Actuation solenoid

Standard (with plug)	Without plug	With plug incl. LED's	Nominal voltage
G 12	X 12	L 12	12 V DC
G 24	X 24	L 24	24 V DC
G 24 EX	---	---	24 V DC ³⁾
WG 110	(X 98)	---	110 V AC 50 / 60 Hz
WG 230	(X 205)	---	230 V AC 50 / 60 Hz

¹⁾ Spare part No. for retrofitting or stock etc., see appendix sect. 5.2

²⁾ Versions A(B)BR.. and A(B)BV.. are identical, but the installed position differs (see illustration in sect. 1)

³⁾ An explosion proof solenoid is only available for solenoid version /M (see table 3). p_{max} = 220 bar, Q_{max} = 12 lpm for symbols B and W duty cycle > 75%

3. Further parameters

3.1 General and hydraulic data

Design	Directional spool valve
Surface protection	Spool valve housing and solenoid, zinc galvanized
Installed position	Any, for fastening see dimensional drawings in section 4
Hydr. connection	Via manifold
Port coding	According to dimensional drawing or DIN 24 340-A 6
Flow direction	In accordance with arrow direction in the flow pattern symbols; It is not permissible to reverse the flow direction!
Over lapping	Positive
Operation pressure	$p_{max} = 315$ bar (all ports) $p_{max} = 200$ bar for version with ex-proof solenoid and with version /MP, /MPF (pure throttling spool valve), $Q_{max} = 12$ lpm for symbols B and W duty cycle > 75%
Flow	Flow $Q_{max} = 25$ lpm; Permissible return flow approx. 50 lpm
Hydraulic fluid	Fluids acc. to DIN 51524 table 1 to 3; ISO VG 10 to 68 acc. to DIN 51519 Viscosity range: min. approx. 4; max. approx. 1500 mm ² /s Optimal operation range: approx. 10...500 mm ² /s Also suitable are biologically degradable pressure fluids of the type HEPG (Polyalkylenglycol) and HEES (synth. Ester) at operation temperatures up to approx. +70°C.
Temperature	Ambient: approx. -40...+80°C; Fluid: -25...+80°C, pay attention to the viscosity range! Start temperature down to -40°C are allowable (Pay attention to the viscosity range during start!), as long as the operation temperature during subsequent running is at least 20K higher. Biological degradable pressure fluids: Pay attention to manufacturer's information. With regard to the compatibility with sealing materials do not exceed +70°C. Restrictions for version with ex-proof solenoid!
Mass (weight)	Directional spool valves coding G, D, E, O, K = approx. 1.6 kg; B, Q, W = approx. 1.1 kg + 0.3 kg for versions with pressure switch DG 3

Δp -Q-curve

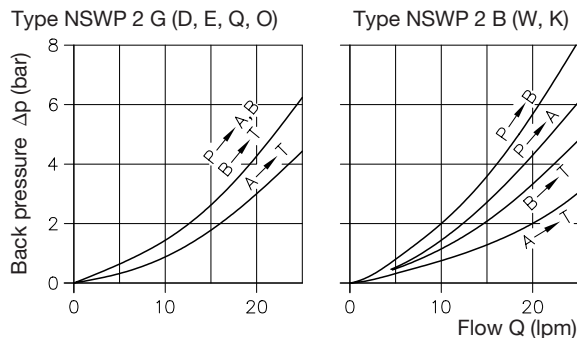

Viscosity during measuring approx. 60 mm²/s

The curves apply to only one flow direction P→T (idle circulation), P→A(B) or A(B)→T. The total back pressure (Δp_{total}) with 4/3- or 4/2-way directional valves is taken at P. It consists of an inflow share (Δp_{in}) and an outflow share (Δp_{out}). Important: Consumers with unequal area ratio (e.g. differential cylinders) show uneven flow at the consumer ports, i.e. also (Δp_{in}) and (Δp_{out}) won't be equal regardless of the direction of movement!

$$Q_{return} = Q_{in} \frac{A_{out}}{A_{in}}$$

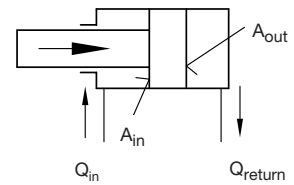
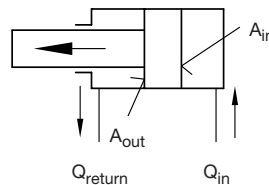

$$\Delta p_{total} = \Delta p_{in} + \Delta p_{out} \frac{A_{out}}{A_{in}}$$

2. speed rate, ports A and B

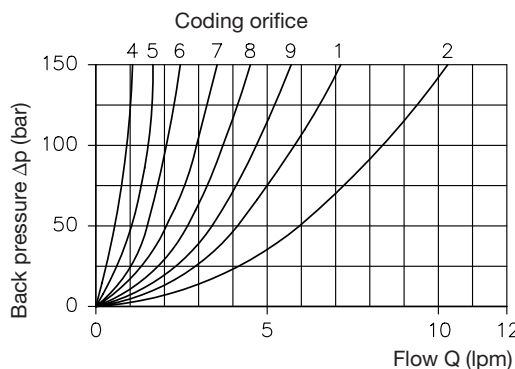

3.2 Solenoid

Solenoid	Wet armature solenoid, manufactured and tested conforming VDE 0580 Reference value for nom. power $P_N \approx 24.4 \text{ W} \pm \text{approx. } 6\% \text{ dep. on nom. voltage } U_N \text{ and make}$								
Coding	G 12 X 12 L 12	G 24 X 24 L 24	G 24 EX ²⁾	G 48 X 48	G 80 X 80	G 98 X 98 ¹⁾	G 205 X 205 ¹⁾	WG 110	WG 230
Nominal voltage U_N	12 V DC	24 V DC	24 V DC	48 V DC	80 V DC	98 V DC	205 V DC 50/60Hz	110 V AC 50/60Hz	230 V AC
Nom. power P_N (W)	28	28	23	28	28	28	28	28	28
Nom. current I_{20} (A)	2.34	1.17	0.97	0.58	0.35	0.28	0.14	0.28	0.14
Port and circuitry (valid for solenoid a and b)	DC-voltage Coding G..			Coding L...			AC-voltage Coding WG..		
Plug	EN 175 301-803 A, see also D 7163						Gray plug	Black plug	
	Coding G (...V DC) is only available with gray or black plugs. Coding WG (...V AC) is only available with black plugs, featuring an internal bridge rectifier circuit								
Relative duty cycle	100% Stamping on the solenoid		Operation:		at ambient temperature (°C)		< 40	60	80
					Duty cycle (%)		100	approx. 60	approx. 40
Switching times (ref. value)	On: approx. 60 ... 70 ms		Off: approx. 30 ... 60 ms						
Switching operations	approx. 3600 switchings / h								
Protection class	IP 65 (IEC 60529) (plug properly mounted)								
Insulation material class	H								
Surface temperature	approx. 85°C at 20°C ambient temperature								
Mounting	Coding /M:			The solenoid can be simply axially removed and replaced by a new one after undoing the knurled screw.					
	Coding /MP, /MPF:			The solenoid can be simply axially removed and replaced by a new one after removal of the circlip.					
	Coding /MK, /MD, /MM...:			The solenoid can be simply removed and replaced by a new one after undoing of the 4 tension rods / screws.					

Prop.-solenoid coding /MP.. (differing of above):

Solenoid	conforming VDE 0580	
Nom. voltage U_N	12 V DC	24 V DC
Coil resistance R_{20}	6.0 Ω	24.0 Ω
Current, cold I_{20}	2.5 A	1.25 A
Nom. current $I_N \approx 70\% \text{ of } I_{20}$	1.35 A	0.88 A
Power, cold $P_{20} = R_{20} \times I_{20}^2$	30 W	30 W
Nom. power $P_N = R_{20} \times I_{20}^2$	21 W	21 W
Required dither frequency	50 ... 80 Hz	
Dither amplitude	20 ... 40% of I_N	
Relative duty cycle	100% (reference temp. $\vartheta_{11} = 50^\circ\text{C}$)	

²⁾ Explosion-proof version

ATEX-Certificate of conformity	TÜV-A 12ATEX 0006 X
Coding	⊕ II 2 G Ex d IIB + H2 T4 Gb ⊕ II 2 D Ex tb IIIC T135°C Db
Oper. duration	100% ED
Duty cycle	IP 67 (IEC 60529)
Nom. voltage U_N	24 V DC
Power P_N	23 W
Restrictions for use:	
Ambient temperature	-35 ... +40°C
max. fluid temperature	+70°C
el. protection against overload (conf. IEC 60127)	$I_F < 1,6 \text{ A-T}$
Surface coating	Housing galvanically zinc coated Coil and connection cavity are moulded
Electrical connection	3x0,5 mm ²
Cable length	3 m, Option 10 m (cable ÖLFLEX-440P ® Co. LAPP, D-70565 Stuttgart)

¹⁾ These solenoids are intended to be connected via a customer furnished bridge rectifier to mains 50/60Hz: G 98 (X 98) for mains 110 V AC; G 205 (X 205) for mains 230 V AC

Attention: Protect the complete valve against direct sun light.

Observe the operation manuals B 03/2004 and B ATEX!
Electrical lay-out and testing conforming EN 60079, VDE 0170-1, VDE 0170-5

4. Unit dimensions

All dimensions in mm, subject to change without notice !

4/3- and 4/2-way directional spool valves
coding **G, D, E, O, K**

(Illustration with solenoid /M, for other solenoids see below)

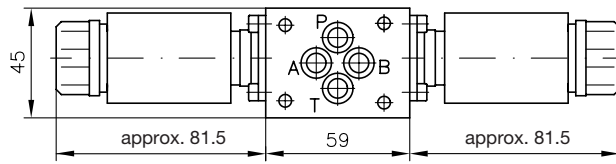

Port	∅ d	Sealing via O-ring NBR 90 Sh
A and B	7	9.25 x 1.78
P	6.5	
T	7	

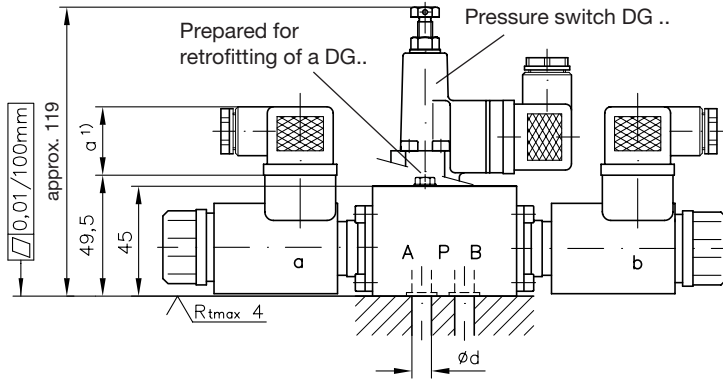

4/2-way directional spool valve

Coding **W**

Coding **B and Q**

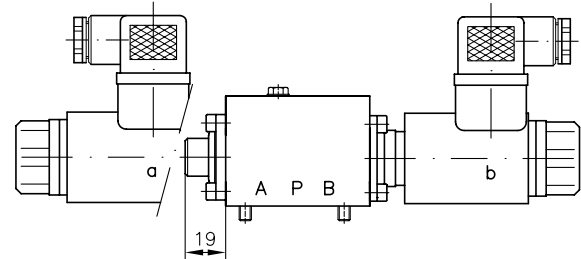

Additional solenoids acc. to table 3, sect. 2

/M.. - G 24 EX

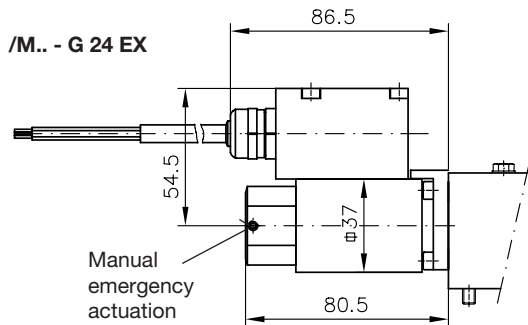

Hole pattern of the manifold (top view)

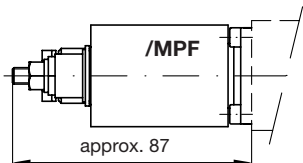
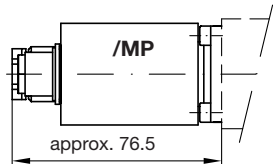
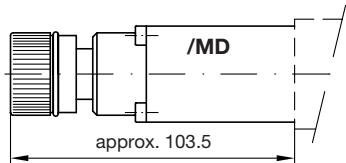
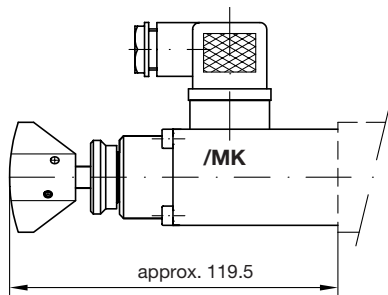
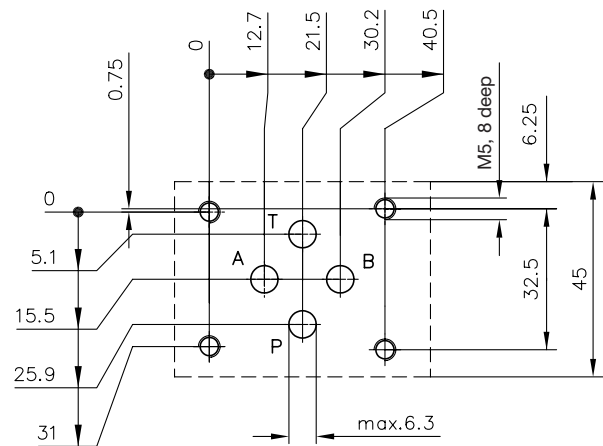

/MM..

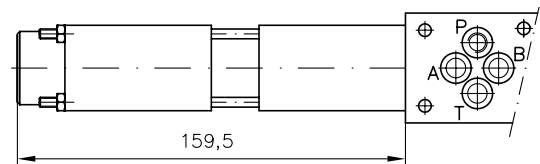

For missing specifications, see above!

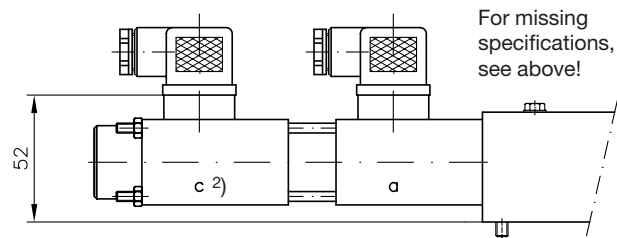

- 1) a = 29 (G 12 to G 205); 34 (WG 230)
This dimension depends on the manufacturer and may be up to 40 mm acc. to EN 175 301-803 A !
- 2) Solenoid c for 2. speed rate

Version with individual connection block

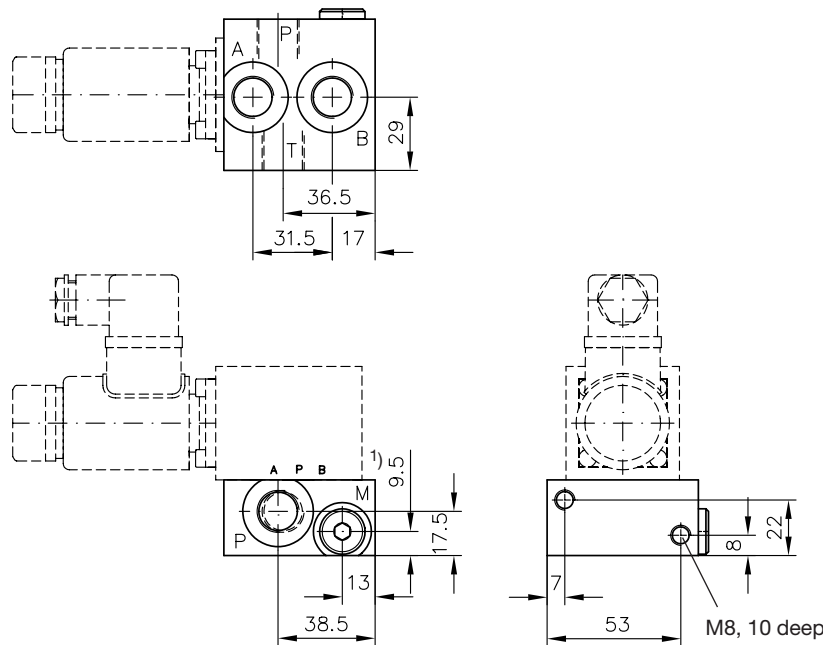

Ports conf. ISO 228/1 (BSPP):
A, B, P, T = G 3/8
(M = G 1/4)

1) M, can be used only together with clamping module type NSMD acc. to D 7787

5. Appendix
5.1 Notes regarding the uneven solenoid actuation

The notes below have to be observed, when differing solenoid versions are to be combined for a and b:

Order examples: /MM 6 - MK
/M - MD

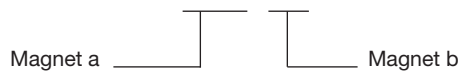

Attention: The stroke limitation (/MK or /MD) at these examples is only active for solenoid a (/MM 6 or /M).

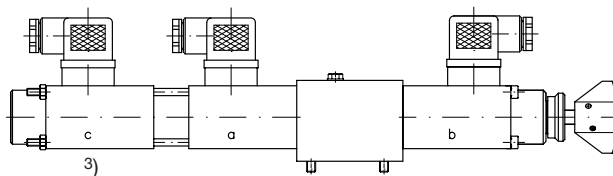

Combination possibilities

Solenoid a	Solenoid b		
	/M, /MD, /MK ²⁾	/MP, /MPF ²⁾	/MM..
/M, /MD, /MK	●	---	●
/MP, /MPF	---	●	---
/MM..	●	---	●

²⁾ Combinations of these are also possible

³⁾ Solenoid c for 2. speed rate

5.2 Parts No. of the orifices, when ordering spare parts

Coding	Parts No.
B ... (at port P)	Grub screw ISO 4026 - M8x8 - ... - 10.9 └ Diameter
R	ER 13
S S 0,2 S 1	ER 14 ER 14/0,2 ER 14/1
ABV ... BBV ... ABR ... BBR ...	EBR 14-B... └ Diameter

Coding	Parts No.
AB ...	7966 003 m (without hole)
BB ...	7966 003 h (∅ 0.3)
	7966 003 i (∅ 0.4)
	7966 003 k (∅ 0.5)
	7966 003 l (∅ 0.6)
	7966 003 a (∅ 0.7)
	7966 003 n (∅ 0.8)
	7966 003 f (∅ 0.9)
	7966 003 b (∅ 1.0)
	7966 003 g (∅ 1.2)
	7966 003 c (∅ 1.5)
	7966 003 d (∅ 2.0)
	7966 003 e (∅ 2.5)

5.3 Type coding

Order example:

NSWP 2 D 06/M/B0,8R/ABR1,0/20/ S - G 24 - 3/8

