

1. Installation notes

It is important that you analyze all aspects of your application and review all information concerning this product (see also D 7600-3L) before you select or use any product or system. Due to the variety of operating conditions and applications for these products, the user, through his own analysis and testing, is solely responsible for making the final selection of the products and assuring that all functionality and safety requirements of his application are met. Installation, adjustments, maintenances, and repairs have to be performed by authorized, trained, and instructed staff only. The use of this product beyond the specified performance limits, with not approved fluids, and/or when non-genuine spare parts installed will lead to an expiration of the guarantee.

The hydraulic power pack can become hot during operation
→ Risk of injury!

The following guidelines and standards have to be taken additionally into account:

- VDI 3027 "Initial operation and maintenance of hydraulic systems"
- DIN 24346 "Hydraulic systems"
- ISO 4413 "Hydraulic fluid power - General rules relating to systems"
- D 5488/1 Pressure fluids - notes for selection
- B 5488 General operating manual for the assembly, initial operation and maintenance of hydraulic components and systems

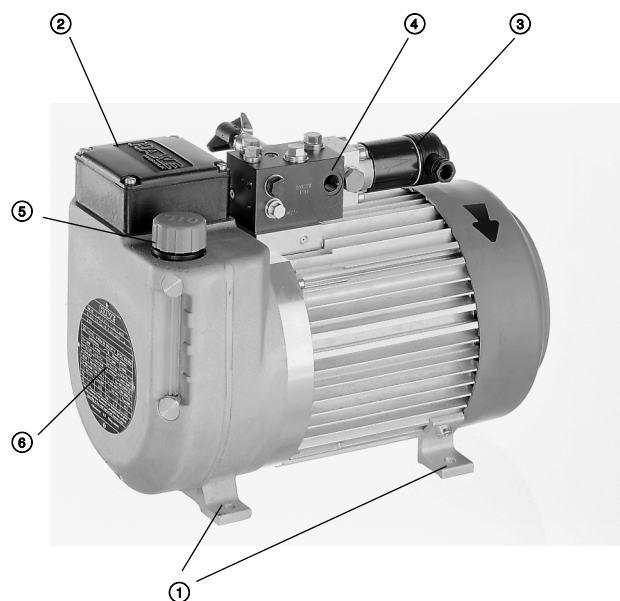

- ① Means of fastening the power pack
- ② Electrical connection of motor and supervision elements (temperature and fluid level switch)
- ③ Electrical connection of valves and supervision elements (e.g. pressure switch)
- ④ Ports for hydraulic connection of consumers
- ⑤ Oil filler neck and breather filter
- ⑥ Type plate for hydraulic power pack and electric motor

Declaration of conformity

Letter of conformity acc. to EC directive 2006/95/EG

„Electrical equipment designed for use within certain voltage limits“

The compact power packs are manufactured in conformity with EN 60 034 (IEC 34 – VDE 0530) and VDE 0110.

Notes: Conforming EC directive machinery safety 89/392 EC, appendix II, section B:

The components are produced conforming the harmonized standards EN 982, EN 983, EN 292 and EN 60204-1. The setting in operation is forbidden until it is verified that the machine where this component is utilized fulfils the requirements in safety of Machinery Directive 89/392/EEC incl. appendix.

2. Coding

Type plate for hydraulic power pack

Single circuit pumps

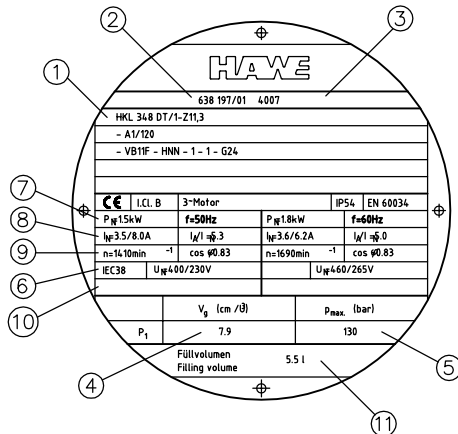

Dual circuit pumps

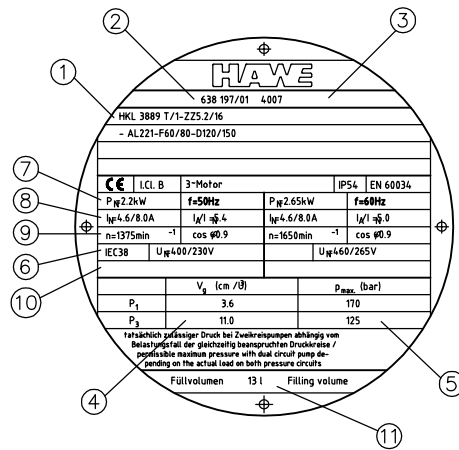

with 1~phase motor

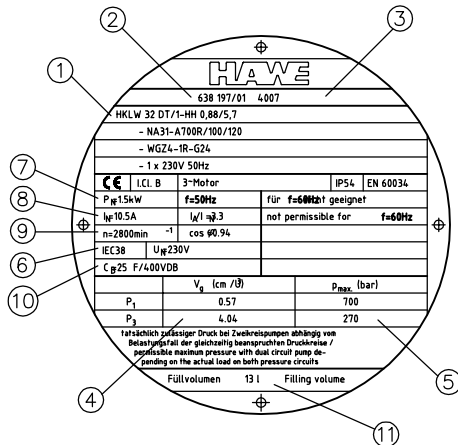

- ① Complete type coding
- ② Commission number
- ③ Production date: Week/Year
- ④ Geometric delivery flow of the pump, flow Q (l/min) = V_g · n / 1000
- ⑤ Max. perm. operating pressure
- ⑥ Nom. voltage and mains frequency according to circuitry (Y, Δ, ⊥)
Voltage ranges (Y, Δ, ⊥), where the rated performance is available:
- 50 Hz: ±10% (IEC 38)
- 60 Hz: ±5%
- ⑦ Nom. power according to mains frequency (50 Hz, 60 Hz)
⚠ The actual power consumption can be higher than the nom. power!
- ⑧ Nom. current
⚠ The actual current consumption can be higher than the nom. current!
- ⑨ Nom. speed
- ⑩ Operating capacitor
⚠ Not scope of supply!
- ⑪ Tank capacity

Type coding

Order example:

Single circuit pump

HKL 34 DT/1 - H 7,7 - A1/1503 x 400/230 V \sphericalangle 50 Hz

Dual circuit pump

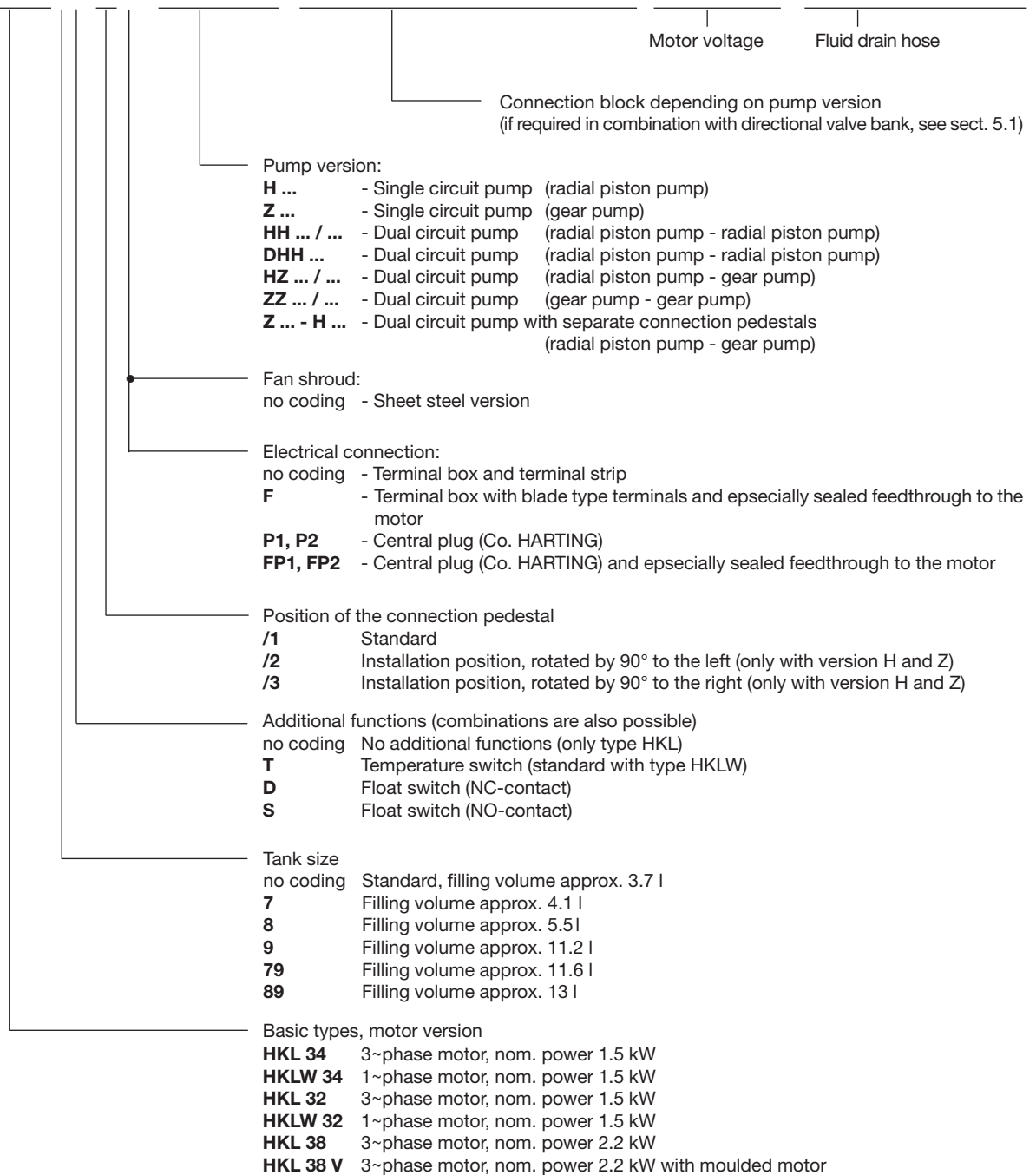
HKLW 328T /1C - HZ 0,88/5,2 - NA31-A700R/100/120-WGZ4-1R-WG110 -1 x 110 V 60 Hz - Fluid drain hose G 1/4 x 300

3. Further characteristic data

3.1 General

Nomenclature Constant delivery pump
 Design Valve controlled radial piston pump or gear pump
 Direction of rotation Radial piston pump -- Any
 Gear pump - Counter clock-wise, as indicated by an arrow on the fan shroud. It is therefore necessary to check the rotation direction of the motor. The fan wheel has to rotate counter clockwise after briefly starting the motor when looking through the perforation of the fan shroud.

Speed range Radial piston pump H: 200 ... 3500 min⁻¹
 Gear pump Z 1.1 ... Z 3,5: 500 ... 4500 min⁻¹ Z 4.5 ... Z 5.2: 500 ... 3200 min⁻¹
 Z 6.4 ... Z 6,9: 500 ... 2400 min⁻¹ Z 8.2 ... Z 8.8: 500 ... 1800 min⁻¹
 Z 11.3: 500 ... 1500 min⁻¹ Z 6.5 ... Z 21: 500 ... 3500 min⁻¹

Installed position Only horizontal

Mounting via four supports with holes Ø9 mm, see also sect. 4.1

Mass (weight) (without fluid)	Basic type	H	Z	HZ, HH, DHH, Z - H
HKL 3 HKLW 3.		19.7 kg	19.7 kg	20.5 kg
HKL 3.7 HKLW 3.7		21.9 kg	21.9 kg	22.7 kg
HKL 3.8 HKLW 3.8		27 kg	27 kg	27.5 kg
HKL 3.9 HKLW 3.9		21.5 kg	21.5 kg	22.3 kg
HKL 3.79 HKLW 3.79		23.7 kg	23.7 kg	24.5 kg
HKL 3.89 HKLW 3.89		28.8 kg	28.8 kg	29.3 kg

For mass (weight) of the connection blocks and valve banks, see the respective pamphlets (see listing in sect. 5.1)

Pipe connection only via directly mounted connection blocks, see selection table in section 5.1. For the connection hole pattern of the basic pump, see section 4.3

Running noise

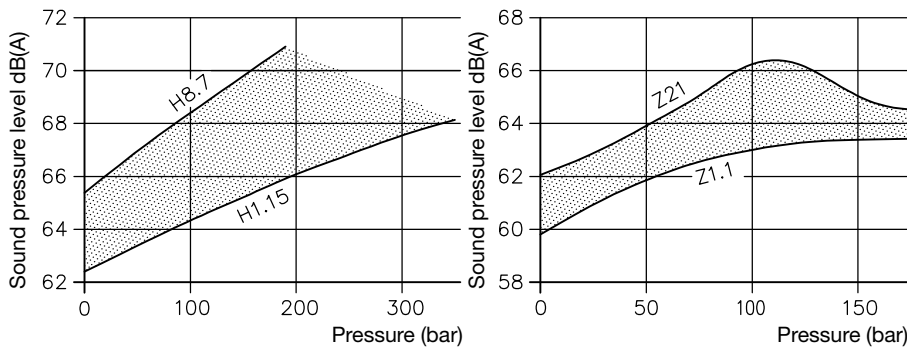

Measuring conditions:
 Work room, interference level approx. 50 dB(A); Measuring point 1m above the floor; 1 m object clearance, pump fixed with 4 silent-blocs Ø40x30 65 Shore, (Co. Schwingmetall No. 20291/V).

Measuring device:
 Precision sound pressure level measuring instrument IEC 651 class I

Viscosity of the oil: approx. 60 mm²/s

Note:

Pumps with smaller delivery flows tend as a rule to the lower, whereas larger ones tend to the upper limit. The noise level of dual circuit pumps are similar to the one of single circuit radial piston pumps, if the total delivery flow is rather identical.

3.2 Hydraulic

Pressure Delivery side (outlet ports P, P1 und P3) depending on pump design and delivery flow, see sect. 2
 Suction side (inside the tank): ambient pressure. Not suitable for charging.

Start-up against pressure Versions with 3~phase motor will start-up against pressure p_{max}!
 Whereas versions with 1~phase motor will start-up only against slight pressure!

Pressure fluid Hydraulic oil conforming DIN 51 524 part 1 to 3; ISO VG 10 to 68 conforming DIN 51 519
 Opt. operation range: Radial piston pump H: 10 ... 500 mm²/s
 Gear pump Z: 20 ... 100 mm²/s
 Viscosity range: min. approx. 4; max. approx. 800 mm²/s
 Also suitable are biologically degradable pressure fluids type HEES (Synth. Ester) at service temperatures up to approx. +70°C. Electrically hazardous: Any fluid types containing water must not be used (short-cut). i.e. fluids type HEPG and HETG are not suitable!

Temperature Ambient: approx. -40 ... +80°C; Fluid: -25 ... +80°C. Note the viscosity range !
 Permissible temperature during start: -40°C (observe start-viscosity!), as long as the service temperature is at least 20K higher for the following operation. Biologically degradable pressure fluids: Observe manufacturer's specifications. By consideration of the compatibility with seal material not over +70°C.

Filling and usable volume	Tank size	Filling volume	Usable filling volume	
	Coding	V _{filling}	V _{usable} (coding H, Z)	V _{usable} (coding HZ, HH, DHH, Z - H)
	--	3.7 l	1.7 l	1.7 l
	7	4.1 l	2.1 l	1.7 l
	8	5.5 l	2.6 l	1.7 l
	9	11.2	8.2 l	8.2 l
	79	11.6 l	8.6 l	8.2 l
	89	13 l	9.1 l	8.2 l

3.3 Electrical data

The figures below apply to radial piston as well as to gear pumps
 The drive motor and pump form a closed, not separable unit, see description section 1.

- Connection
- Version with terminal box, WAGO CAGE CLAMP®S, cable 1.5 mm² ... 3 mm² (Cable gland M20x1.5 is customer furnished)
 - Version with central plug (Co. HARTING), cable 1.5 mm²
 - Version with terminal box and blade type terminals, blade type terminals (female) 6.3 (Co. AMP) (cable gland M20x1.5 is customer furnished)
- Protection class IP 54 conf. IEC 60529, apply to the complete hydraulic power pack (as a reference protection class to pure electrical machinery)
- Safety class VDE 0100 Safety class 1
- Insulation Design conf. VDE 0110
- for mains with 4 or 3 conductors L1~L2-L3~PE (3~phase mains) with grounded neutral point up to 500 V AC nom. phase voltage conductor - conductor
 - for mains with 4 or 3 conductors L1~L2-L3 (3~phase mains) without grounded neutral point up to 300 V AC nom. phase voltage conductor - conductor
 - for 1~phase mains with 2 conductors L-N up to 300 V AC nom. voltage.

Current consumption

HKL 34, HKL 38 3 x 400/230V 50 Hz $\nabla\Delta$
 Operating voltage 3 x 460/265V 60 Hz $\nabla\Delta$

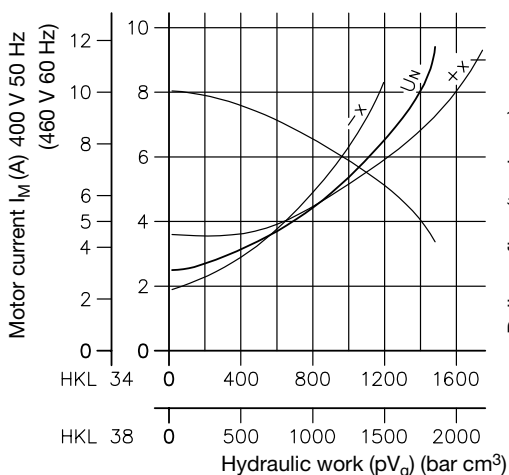

HKL 32 3 x 400/230V 50 Hz $\nabla\Delta$
 Operating voltage 3 x 460/265V 60 Hz $\nabla\Delta$

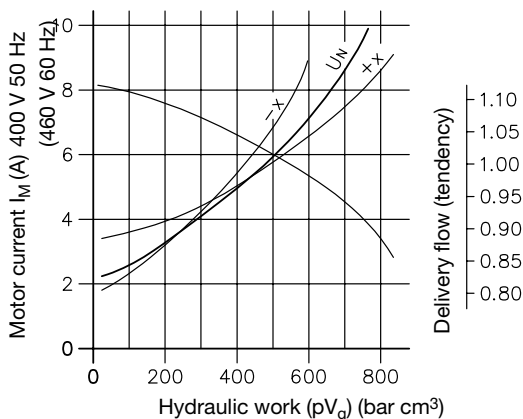

HKLW 34 1 x 230V 50 Hz
 Operating voltage 1 x 110V 60 Hz

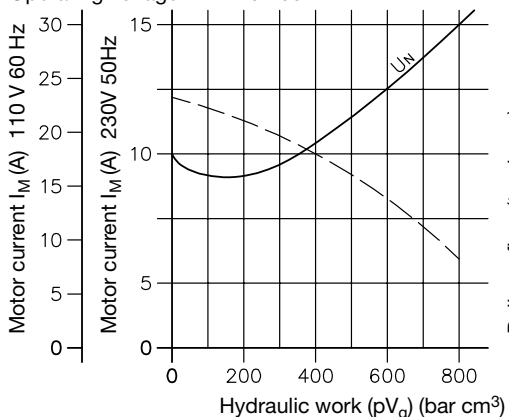

HKLW 32 1 x 230V 50 Hz
 Operating voltage 1 x 110V 60 Hz

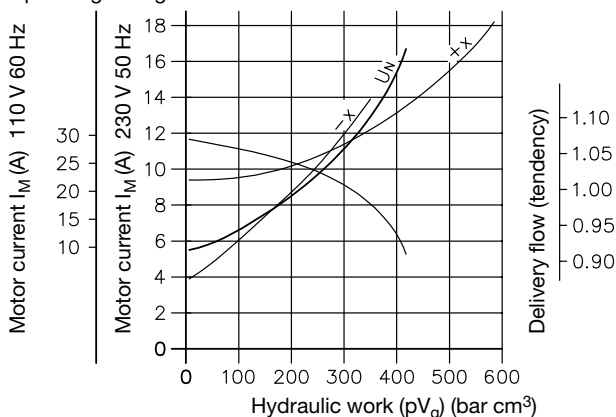

Temperature switch Coding T

Technical data:
 Bimetallic switch
 HKLW = winding protective switch
 HKL = temperature switch, mounted separately
 Signaling takes place at 80°C ± 5K (Kelvin)
 Max. voltage 250 V 50/60 Hz
 Nom. current (cos φ ~0,6) 1.6 A
 Max. current at 24 V (cos φ = 1) 1.5 A
 Connection – in the terminal box / plug Co. HARTING



Float switch Coding D, S

Technical data:
 Switching performance DC/AC 60 W/ 60 VA
 Max. current DC/AC 0.8 A (cos φ = 1)
 Max. voltage 230 V 50/60 Hz
 A protective circuitry is mandatory at inductive loads!

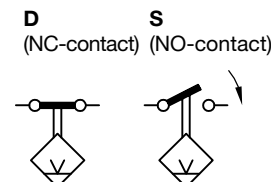

Continuation 4.2 Basic pump type HKL and HKLW

Coding P1, FP1

Coding P2, FP2

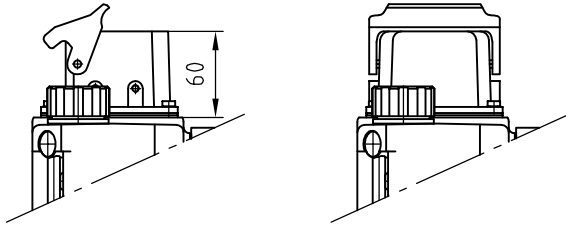

Type HKL 3.9, HKL 3.89
Type HKL W 3.9, HKLW 3.89

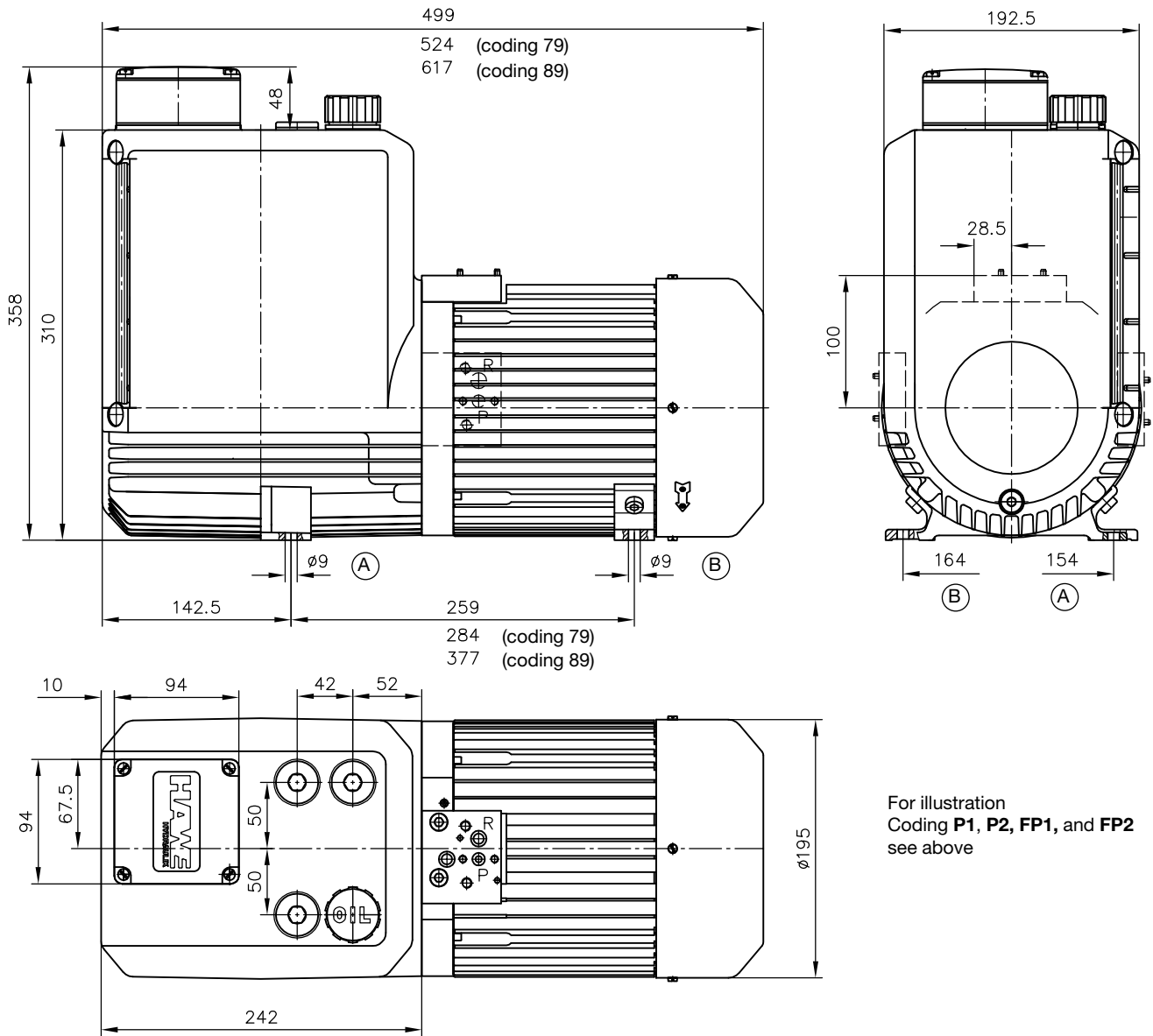

For illustration
Coding **P1, P2, FP1, and FP2**
see above

Fluid drain hose G 1/4 x 300
G 1/4 x 500

Fluid drain hose G 1/4 W x 300
G 1/4 W x 500

G = BSPP

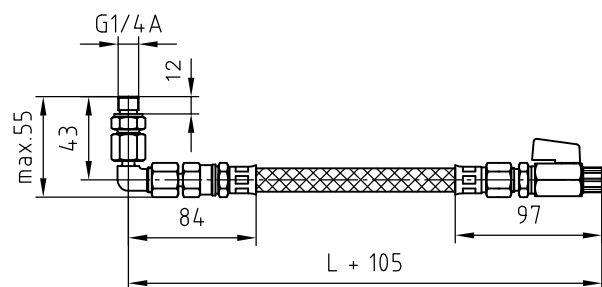
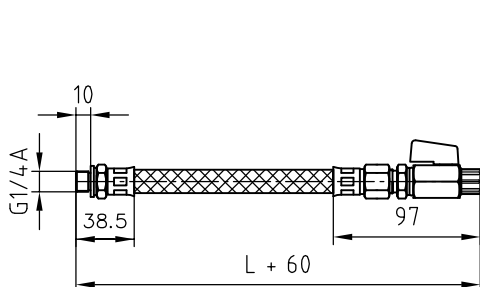

4.3 Electrical and hydraulical connection

Hydraulical

Single circuit pump

Dual circuit pump with a separate connection pedestal

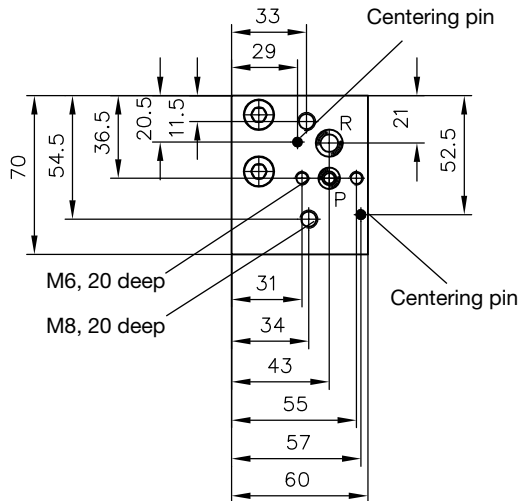

Dual circuit pump with common connection pedestal.
For missing dimensions, see above!

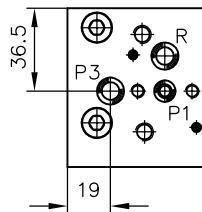

Ports at a customer furnished connection block

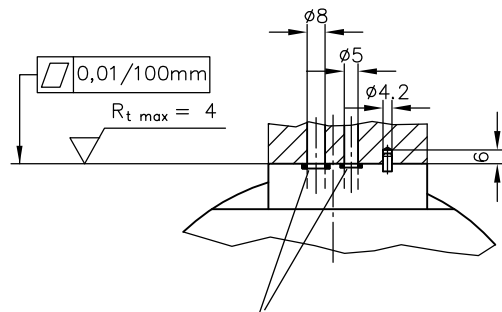

Sealing of ports:

P and P1 = Kantseal 6.07x1.68 NBR 90 Sh

P3 and R = 8x2 NBR 90 Sh

Electrical

Terminal box (without coding)

WAGO CAGE CLAMP@S, cable 1.5 mm² ... 3 mm²

3~phase motor

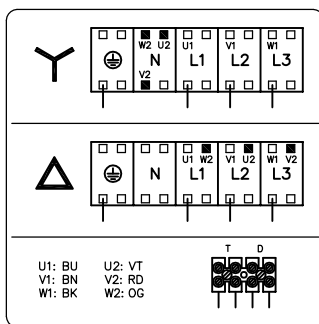

1~phase motor

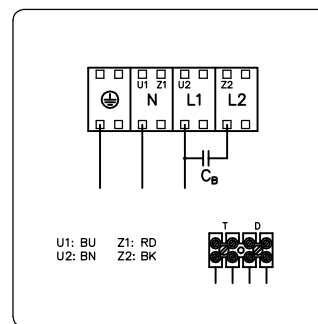

D (NC-contact) **S** (NO-contact) **T**

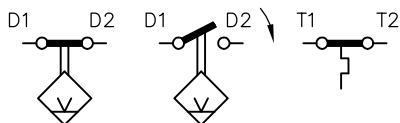

C_B - Operating capacitor is not scope of delivery

Coding P1, P2, FP1, FP2
Central plug (Co. HARTING) HAN 10 E

3~phase motor

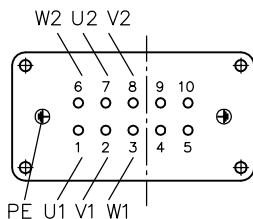

1~phase motor

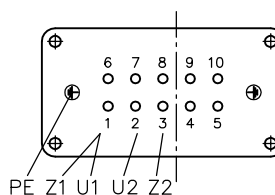

C_B - Operating capacitor is not scope of delivery

Electrical connection at the user (via the plug)

3~phase motor Υ

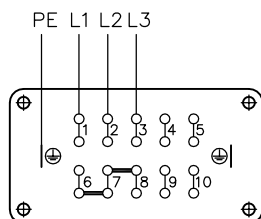

3~phase motor Δ

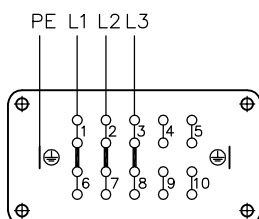

1~phase motor

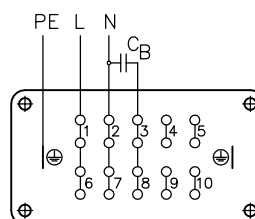

Coding **D, S**

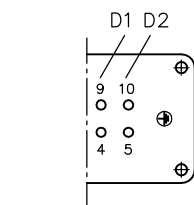

D (NC-contact) **S** (NO-contact)

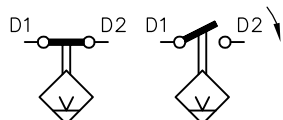

Coding **T**

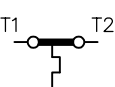
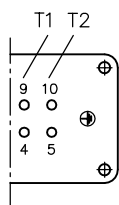

Coding **DT, ST**

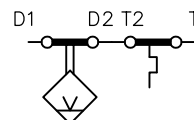
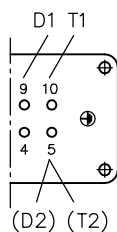

Coding **D - T, S - T**

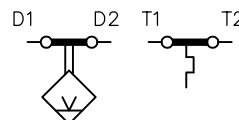
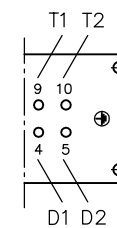

Coding **F**

Blade type terminals, blade type terminals (female) 6.3 AMP

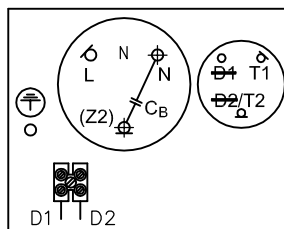
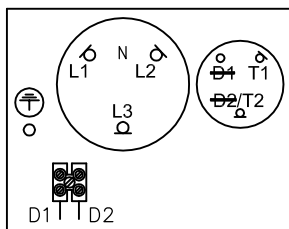

C_B - Operating capacitor is not scope of delivery

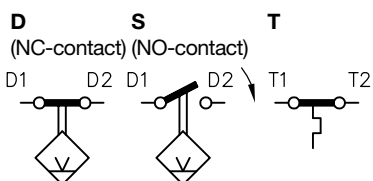

5. Appendix

5.1 Notes regarding selection

Procedure for selection and system lay-out of compact power packs with directly mounted valves is detailed in D 7600-3L.

Technical description of the connection blocks

A connection block is mandatory for the hydraulic connection of the hydraulic power pack

Type	Description	Pamphlet
A, AL, AM, AK, AS, AV, AP	For single circuit pumps with pressure limiting valve and the possibility for direct mounting of directional valve banks Optional: pressure resistant filter or return filter, idle circulation valve, accumulator charging valve, prop. pressure limiting valve	D 6905 A/1
AN, AL, NA, C30, SS, VV	For dual circuit pumps with pressure limiting valve and where directional valve banks can be directly mounted in some cases Optional: accumulator charging valve, two stage valve, idle circulation valve	D 6905 A/1
AX	For single circuit pumps with pressure limiting valve (type approved) and the possibility for direct mounting of directional valve banks for use at accumulator charged systems Optional: pressure resistant filter or return filter, idle circulation valve	D 6905 TÜV
B	For single circuit pumps for actuating single acting cylinders with pressure limiting valve and drain valve Optional: throttle valve	D 6905 B
C	For single circuit pumps with ports P and R for direct piping	D 6905 C

Technical description of the directional valve banks

The direct mounting of directional valves to the connection blocks type A enables creation of compact hydraulic units without additional piping.

Type	Description	Pamphlet
VB	Directional seated valves up to 700 bar	D 7302
BWN, BWH	Directional seated valves up to 450 bar	D 7470 B/1
BVZP	Directional seated valves up to 450 bar	D 7785 B
SWR, SWS	Directional spool valves up to 315 bar	D 7451, D 7951
BA	Valve bank for the combination of different directional valves with connection hole pattern NG 6 acc. to DIN 24 340-A6	D 7788
NBVP	Directional seated valves	D 7765 N
NSWP	Directional spool valves	D 7451 N
NSMD	Clamping modules (Directional spool valve with pressure reducing valve and feedback signal)	D 7787
NZP	Intermediate plate with connection hole pattern Ng 6 acc. to DIN 24 340-A6	D 7788 Z

5.2 Assembly and installation notes

Attention: The compact hydraulic power pack has to be installed and connected by a qualified technician, who is familiar with and works according to the generally accepted engineering standards and the latest legal regulations and standards.

The following guidelines and standards have to be taken into account:

- VDI 3027 "Initial operation and maintenance of hydraulic systems"
- DIN 24346 "Hydraulic systems"
- ISO 4413 "Hydraulic fluid power -- General rules relating to systems"
- D 5488/1 Pressure fluids - notes for selection
- B 5488 General operating manual for the assembly, initial operation and maintenance of hydraulic components and systems

a) Identification

see type plate and discription in section 2

b) Installation and mounting

- Installation

⚠ The hydraulic power pack incl. the solenoids of the directional valves can become hot during operation → Risk of injury!
Care has to be taken that fresh air can be drawn in and the warm air can escape.
Modifications of any kind (mechanical, welding or soldering works) must not be performed.

- Installed position only horizontally
- For dimensions, see sect. 4.2
- Mass (weight) for the basic power pack without valve assembly and fluid

Basic types	H	Z	HZ, HH, DHH, Z - H
HKL 3 HKLW 3.	19.7 kg	19.7 kg	20.5 kg
HKL 3.7 HKLW 3.7	21.9 kg	21.9 kg	22.7 kg
HKL 3.8 HKLW 3.8	27 kg	27 kg	27.5 kg
HKL 3.9 HKLW 3.9	21.5 kg	21.5 kg	22.3 kg
HKL 3.79 HKLW 3.79	23.7 kg	23.7 kg	24.5 kg
HKL 3.89 HKLW 3.89	28.8 kg	28.8 kg	29.3 kg

- Mounting: Mounting hole pattern, see section 4.1

c) Electrical connection and setting of the protective motor switch

- For connection of the electric motor, see sect. 4.3
- For connection of the float and fluid level switch, see sect. 4.3
Note: The temperature switch will trigger at a fluid temperature of approx. 95°C.
Note: The signal has to be delayed sufficiently (time lag relay) if the lay-out of the system features an operation cycle where the pump is emptied below the min. level and replenished by the reflow from the consumer within one cycle.
- Adjustment of the protective motor switch
 - S1-operation (pressure $\leq p_1$)
The protective motor switch should be set for the corresponding current, required to achieve the adjusted pressure of the pressure limiting valve (see I_M -(p_V)calc.- curve sect. 3.3), however not higher than the nom. current I_N . This motor protection covers only a possible mechanical blockade of the motor.
 - S6-operation (pressure $\leq p_{max}$)
In most cases it is sufficient, to set the response current to approx. (0.85...0.9) of I_N . This makes sure that on one hand the bimetallic switch does not trigger too early during normal operation but on the other hand the oil temperature doesn't rise too high due to a prolonged response time after the pressure limiting valve is in action.
 - Test the setting of the motor protective switch during a test run.
Temperature switches, float switches and pressure switches are further safety measures against malfunctions.
- Selection of the proper operation capacitor with type HKLW A capacitor is mandatory for the version with 1+phase motor. The recommendations in sect. 3.3 ensure that the max. pressure rating specified are achieved. The electric loss can be minimized by utilizing a smaller capacitor (- 30%) as long as only 75% of the specified max. hydraulic work (pV_G) is employed
Note: The capacitor is not scope of delivery.

Condenser choice Motor voltage	Reference voltage
1 x 230V 50 Hz 1 x 220V 60 Hz	400 V AC
1 x 110V 60 Hz 1 x 115V 50 Hz	230 V AC

d) Notes to ensure EMC (Electromagnetic compatibility)

No impermissible spikes are emitted (EN 60034-1 sect. 19) when hydraulic power packs (inductive motor acc. to EN 60034-1 sect. 12.1.2.1) are connected to a system (e.g. power supply acc. to EN 60034-1 sect. 6). Tests regarding the conformity with EN 60034-1 sect. 12.1.2.1 and/or VDE 0530-1 are not required. Electro-magnetic fields may be generated during switching the motor ON/OFF. This effect can be minimized by means of a filter e.g. type 23140, 3 • 400 V AC 4 kW 50-60 Hz (Co. Murr-Elektronik, D-71570 Oppenweiler

e) Putting into operation

- Check, whether the compact hydraulic power pack is professionally connected.
 - Electrically: Power supply, controls
 - Hydraulically: Piping, hoses, cylinders, motors
 - Mechanically: Fastening at the machine, the frame, and the rack
- A protective motor switch should be employed to safeguard the electric motor. For current setting, see sect. 5.2 c
- The pressure fluid to top-up the power pack should have passed the system filter or be fed via a filter unit always. Only mineral oils conforming DIN 51524 part 1 to 3, type HL or HLP, with a viscosity of ISO VG 10 to 68 acc. to DIN 51519 are suited for use with this power pack. The water content must not exceed 0.1% (Danger of short-cut!) Also suitable are biologically degradable pressure fluids type HEES (Synth. Ester) at service temperatures up to approx. +70°C. Electrically hazardous: Any fluid types containing water must not be used (short-cut) i.e. fluids type HEPG and HETG are not suitable! The compact hydraulic power pack has to be topped-up to the max. marking of the fluid level gauge/dip-stick.

Filling and usable volume	Tank size	Filling volume	Usable filling volume	
	Coding	V _{filling}	V _{usable} (coding H, Z)	V _{usable} (coding HZ, HH, DHH, Z - H)
	--	3.7 l	1.7 l	1.7 l
	7	4.1 l	2.1 l	1.7 l
	8	5.5 l	2.6 l	1.7 l
	9	11.2	8.2 l	8.2 l
	79	11.6 l	8.6 l	8.2 l
	89	13 l	9.1 l	8.2 l

- Initial operation and bleeding
The pump cylinders will be bled automatically if the pump is switched on and off several times while the connected directional valves are switched into a switching position where idle circulation is provided, if possible with your circuitry (see circuit diagram). Another way is to install a pipe fitting with a short piece of pipe and prolonged by a translucent tube. The other end of the tube should be put into the filler neck (breather removed), held firmly and sealed with a non-fluffing cloth. Now switch on the pump and let it run until no more bubbles are visible. Next after the pump cylinders are bled any air dragged into the system should be removed by opening the bleeder screws at the consumers (if provided) until no more bubble are detected or by operating all functions of the circuitry without load until all cylinders, motors, etc. move steadily and without any hesitation.
- Pressure limitation and pressure reducing valves
Do not make any changes of the pressure setting without simultaneously checking the pressure with a pressure gauge!
- Directional valves
Solenoid valves apparent are to be connected to the controls according to the hydraulic wiring diagram and functional diagram.
- Accumulator charged systems
Accumulators have to be filled with appropriate equipment according to the pressure specifications of the hydraulic wiring diagram. The respective operating manuals have to be taken into account.
- Run-down
A certain pressure rise will occur due to pump motor run-down, if the pump is directly connected to a hydraulic cylinder via a pipe, such as e.g. in the typical connection pattern for clamping equipment (connection block B...) and if the power unit is switched off by a pressure switch as soon as a pre-selected pressure is achieved. The extent of this additional pressure rise depends on the pre-selected pressure, the volume of the connected consumers and the pump delivery rate. If such pressure rises are undesired, it will be necessary to reset the pressure limiting valve to match the shut-off point of the pressure switch. The result will be that all excess delivery of the pump during run-down will be conducted to the tank via the pressure limiting valve.

Procedure for matching is as follows:

1. Fully open the pressure limiting valve.
2. Adjusting the pressure switch on highest value (turning the adjustment screw clockwise up to the stop).
3. Start the pump (pressure gauge and all consumers connected) and turn up the pressure limiting valve until the pressure gauge shows the desired final operation pressure.
4. Turn back the pressure switch until the pump is switched off at the desired pressure (see point 3.).
5. Lock pressure switch and pressure limiting valve in position.

The effect of excessive run-down pressure may also be minimized by utilizing an accumulator or providing additional volume in the consumer line.

If the compact hydraulic power pack is running under full load, i.e. the preset pressure is close to the maximum permissible pressure, then effectively no run-down will occur, as the pump will stop almost immediately after shut-off.

5.3 Servicing

The hydraulic power packs type MP and the valves being directly mounted onto the hydraulic power pack are almost maintenance free. Only the fluid level should be checked regularly depending on operation conditions.

The fluid should be exchanged every year as a general rule, but more frequently if tests show aging or contamination.

Attention:

Prior to maintenance and repair works the system has to be:

- depressurized (hydraulic side). This applies especially to systems with hydraulic accumulators
- cut-off or deenergized

Repairs and spare parts

Repairs (replacing service items) are possible by competent craftsmen. The motor can't be repaired or replaced by the customer. Therefore if the motor is defect, the complete pump should be returned to our facilities for an overhaul. There are spare parts lists available, pls. state your pump type acc. to the type plate either on the pump or on the cover plate.