

Connection blocks type HMP with integrated lifting and lowering function for proportional spool valves type PSL and PSV, size 2 and 3

Basic data

Design	Connection blocks for valve bank design
Pressure p_{max}	250 bar
Flow Q_{max}	160 lpm

Additional technical information:

Size	Design	Pamphlet
2	Manifold mounting design	D 7700-2
2	Valve bank design (directly mounted CAN-controls)	D 7700 CAN
3	Valve bank design	D 7700-3

1. General information

Connection blocks type HMP were developed especially for the actuation of single rod cylinders, especially in hoists of e.g. counter balanced trucks.

In this way several consumers may be moved simultaneously, independently from each other at different velocity and pressure ratings, as long as the sum of the partial flows needed for this is within the total delivery supplied by the pump.

The lift/lower function is controlled by proportional 2/2-way ball seated directional valves type EMP.

These valves do not need an external supply of control oil. The load pressure is transmitted to the LS chain during lifting movements.

Benefits:

- High flow rates for all functions due to hydraulically piloted valves
- Low loss and compact design
- Low power consumption of the pump drive (electric/fuel)
- Minimized heat generation reducing the thermal stress of all components
- Suited for both constant flow or variable displacement pump systems
- Extremely sensitive controls at all functions
- Zero leakage seated valve technology for lifting/lowering function
- No pilot pressure required for lowering (no pump start)

Flexibility:

Modular products for tilting and additional functions based on PSL/PSV range:

- Simple extension for more additional functions
- Optional inflow controllers and pressure limitations to be defined for each section
- Additional functions (e.g. over-center valves etc.) can be integrated via ancillary blocks mounted onto the valve sections

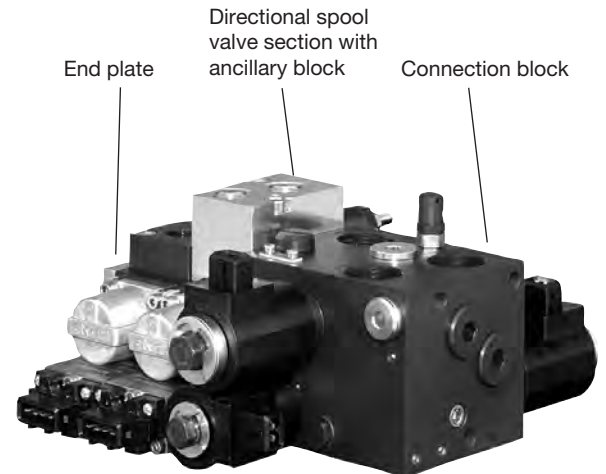
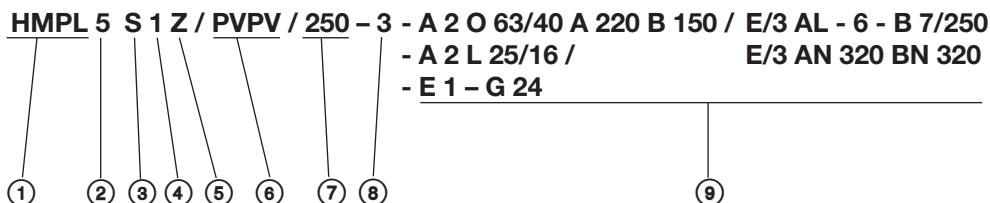

Table of contents

1.	General information	1	5.	Unit dimensions	9
2.	Type coding, overview	2	6.	Appendix	10
3.	Available version, main data	3	6.1	Safety notes	10
3.1	Connection block	3	6.2	Transport and storage.....	10
3.1.1	HMPV	3	6.3	Installation.....	10
3.1.2	HMPV	4	6.4	Application examples	10
3.1.3	Dampening elements for the connection block	5			
3.2	Actuations	5			
4.	Characteristic data	6			
4.1	General and hydraulic	6			
4.2	Curves	7			

2. Type coding, overview

Order coding example:



- ① Basic type code for the connection block
- HMPL** Supply with pressurized oil by means of constant delivery pump (open center)
- HMPV** Supply with pressurized oil by means of variable displacement pump (closed center)
- ② Tapped ports P, R and H acc. to ISO 228/1 (BSPP)
- 4** G 3/4" for size 2
- UNF 4** 1 1/16-12UN-2B (SAE-12) for size 2
- 5** G 1" for size 3
- UNF 5** 1 5/16-12UN-2B (SAE-20) for size 3
- ③ Additional elements
- S, W** Additional dampening element in the LS-line
- B, B 4...7** Orifice in the LS-line
- G** Restrictor check valve
- U** Automatic reduction of the pump circulation pressure via by-pass valve
- ④ Control oil supply (no coding)
- Without pressure reducing valve in case of an external control oil supply (min. 20 bar up to max. 40 bar)
- 1** With integrated pressure reducing valve for the internal supply of control oil (control pressure approx. 20 bar)
- 2** With integrated pressure reducing valve for the internal supply of control oil (control pressure approx. 40 bar)
- ⑤ Optional 2/2-way solenoid valve for arbitrary idle pump circulation (acc. to table 6, sect. 3.1.3) (no coding)
- Without directional valve, but prepared for retrofitting
- Z** De-energized open = idle pump circulation when valve is de-energized
- V** De-energized closed = idle pump circulation when valve is energized
- ⑥ 2/2-way directional seated valves (for add. Information see D 7490/1) (see table 7)
- PVPV** Lifting = EMP/ Lowering = EMP
- VPV** Lifting = EM / Lowering = EMP
- PVV** Lifting = EMP/ Lowering = EM
- ⑦ Tool adjustable pressure limiting valve (main pressure limitation) in the connection block
- /... Pressure setting ... (bar)
- ⑧ Size (hole pattern for mounting subsequent directional spool valves type PSL)
- 2** size 2 (see D 7700-2)
- 3** size 3 (see D 7700-3)
- ⑨ Valve sections and end plates acc. to D 7700-3 and D 7700-2

3. Available version, main data

3.1 Connection blocks

There are two basic variations of connection blocks:

- Connection blocks with integrated 3-way flow controller, suitable for a constant delivery pump system (open-center) - type HMPL (sect. 3.1.1)
- Connection blocks suited for a variable displacement pump system (closed center), a constant pressure systems, or if a second or more, separately located directional spool valve banks are fed in parallel - type HMPV (sect. 3.1.2)

Order coding for a connection block as single section (examples):
(Attention: Size specification absolutely necessary, here 3)

HMPL 5 S1 / PVPV /200 - 3 AMP 12
HMPV 5 B1 Z / PVPV /250 - 3 - G 24

3.1.1 Connection blocks for constant delivery pump systems (with integrated 3-way flow controller) type HMPL

Order example:

HMPL 5 U S 1 V / PVPV/250 - 3 - ... - G 24

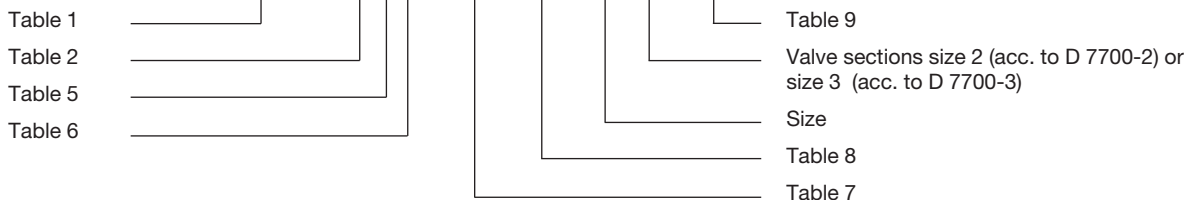

Table 1: Basic type and port size

Coding	Ports P, R and H conf. ISO 228/1 (BSPP)	Max. pump delivery flow (lpm)	Description
HMPL 4..-2	G 3/4	approx. 80	Supply with pressurized oil by means of constant delivery pump (open center) for size -2
HMPL UNF 4..-2	1 1/16-12UN-2B (SAE-12)		
HMPL 4 U..-2	G 3/4	approx. 100	Like HMPL 4 but with automatic reduction of the idle pump circulation pressure via a by-pass valve $Q_{pu} \geq 60$ lpm for version with solenoid actuation
HMPL 5..-3	G 1	approx. 160	Supply with pressurized oil by means of constant delivery pump (open center) for size -3
HMPL UNF 5	1 5/16-12UN-2B (SAE-20)		
HMPL 5 U..-3	G 1	approx. 160	Like HMPL 5 but with automatic reduction of the idle pump circulation pressure via a by-pass valve $Q_{pu} \geq 80$ lpm for version with solenoid actuation
HMPL UNF 5 U..-3	1 5/16-12UN-2B (SAE-20)		

Symbole

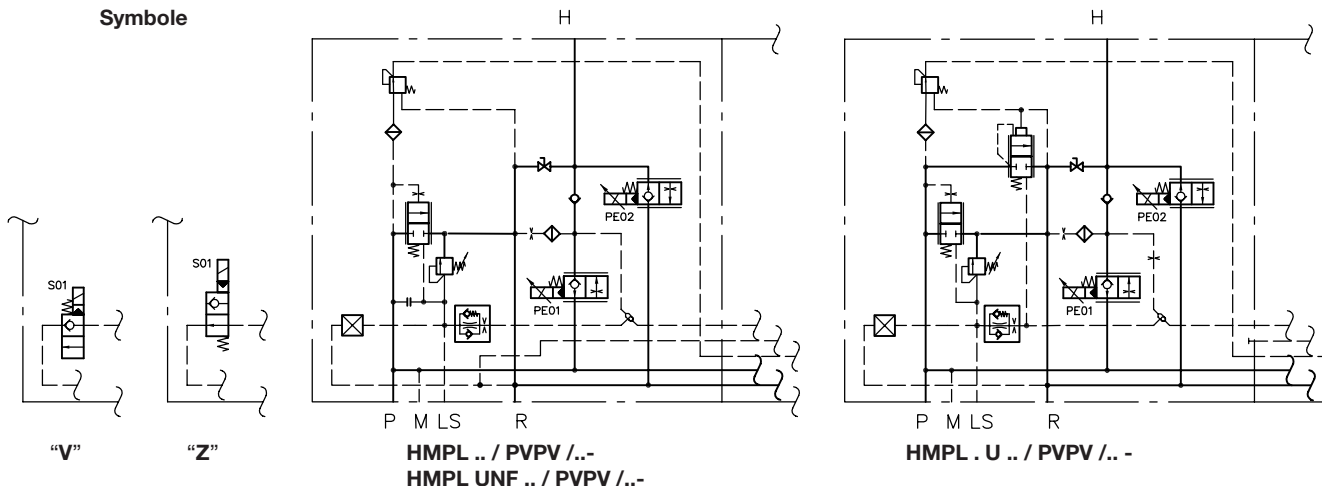

Table 2: Coding for dampening of the LS-signal

Coding	Description
S	Standard (integrated combination of orifice, check valve, pre-load valve pre-load pressure approx. 25 bar)
W	wie Serie, jedoch verstärkte Drosselwirkung
G	Restrictor check valve (without pre-load valve), increased throttling effect, not avail. with type HMPL.U
B	With orifice \varnothing 0.8 mm within LS-duct (to limit control oil flow)
B 4, B 5, B 6, B 7	With orifice \varnothing 0.4 mm, 0.5 mm, 0.6 mm or 0.7 mm at the LS-duct

Note: Do not operate without dampening element otherwise malfunction of the pressure limiting valve.

3.1.2 Connection blocks for variable displacement pump systems / constant pressure system or for additional parallel connected but separately mounted directional spool valves without inflow controller (type HMPV/PSV)

Order example: **HMPV 5 B 1 V /PVPV/250 - 3 - ... - G 24**

Table 3
Table 4
Table 5
Table 6

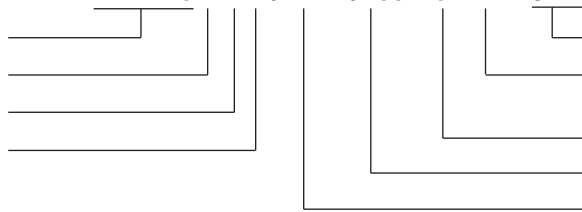
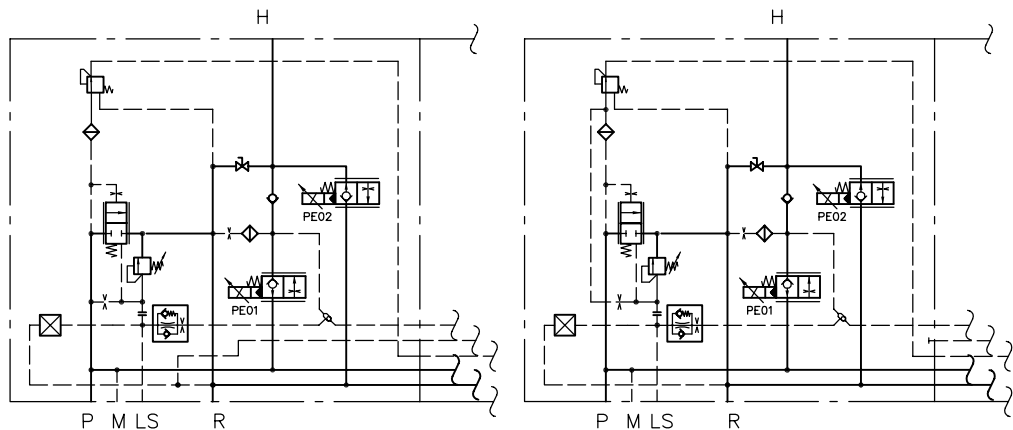

Table 9
Valve sections size 2 (acc. to D 7700-2) or size 3 (acc. to D 7700-3)
Size
Table 8
Table 7

Table 3: Basic type and port size

Coding and size	Ports P, R and H conf. ISO 228/1 (BSPP)	Max. pump delivery flow (lpm)	Description
HMPV 4..-2	G 3/4	100	Supply with pressurized oil by means of variable displacement pump (closed center) with pressure/flow controller for directional valves size -2
HMPV UNF 4..-2	1 1/16-12UN-2B (SAE-12)		
HMPV 5..-3	G 1	160	Supply with pressurized oil by means of variable displacement pump (closed center) with pressure/flow controller for directional valves size -3
HMPV UNF 5	1 5/16-12UN-2B (SAE-20)		

Symbole



**HMPV 4 .. / PVPV /.. - 2
HMPV UNF 4 .. / PVPV /.. - 2**

**HMPV 5 .. / PVPV /.. - 3
HMPV UNF 5 .. / PVPV /.. - 3**

Table 4: Coding for dampening of the LS-signal

Coding	Description
S	Standard (integrated combination of orifice, check valve, pre-load valve pre-load pressure approx. 25 bar)
W	Like S, but with increased throttle effect
B	With orifice \varnothing 0.8 mm within LS-duct (to limit control oil flow)
B 4, B 5 B 6, B 7	With orifice \varnothing 0.4 mm, 0.5 mm, 0.6 mm or 0.7 mm at the LS-duct

Note: Do not operate without dampening element otherwise malfunction of the pressure limiting valve.

3.1.3 Additional elements for connection blocks

Table 5: Coding for control oil supply

Coding	Description
no coding	Without pressure reducing valve for manual or pneumatic actuation or with external control oil supply (20...40 bar)
1	With integrated pressure reducing valve for internal control oil supply for actuations H(HA), HEA).. and E(EA).. or as pick-up for other control valves (max. permissible control oil flow approx. 2 lpm) Control pressure: Coding 1: approx. 20 bar (+ return pressure at R) = standard Coding 2: approx. 40 bar (+ return pressure at R)
2	

Table 6: Arbitrary idle pump circulation of all consumers by means of 2/2-way solenoid valve acc. to D 7490/1

Coding	Description
no coding	(prepared for retrofitting)
Z	With type EM 11 S, idle pump circulation if valve is de-energized (emergency stop)
ZM	Like Z, but with lead sealed wing screw for emergency operation
V	With type EM 11 V, idle pump circulation if valve is energized

Table 7: Lifting and lowering function

Coding	Description	2/2-way directional seated valves acc. to D 7490/1			
		Size 2 Lifting	Lowering	Size 3 Lifting	Lowering
/PVPV	Lifting and lowering proportional	EMP 31 V 80	EMP 31 V 80	EMP 41 V	EMP 41 V
/PV 100 PV 100	Lifting and lowering proportional	EMP 31 V 100	EMP 31 V 100		
/PVV	Lifting proportional, lowering ON/OFF	EMP 31 V 80	EM 31 V	EMP 41 V	EM 41 V
/NPV	Lifting ON/OFF, lowering proportional	EM 31 V	EMP 31 V 80	EM 41 V	EMP 41 V
Note:	Maintaining the lifted position via zero leakage seated valve technology. The switching time strongly depends of flow, pressure and viscosity. Drop rate braking valves on the consumer side are recommended if the drop rate shall be limited. There is an emergency drain valve (allan key a/f 5) enabling controlled lowering, when necessary.				

Table 8: Tool adjustable pressure limiting valve for the main pressure.

Coding	Description
/...	Pressure specification in bar (piloted main pressure limiting valve)

3.2 Actuators

Table 9: Solenoid voltage (electrical actuation)

Coding	Nom. voltage	Description
G 12, X 12	12 V DC	Standard , electr. connection conf. EN 175 301-803 A, with (plug G..) or without (plug X..)
G 24, X 24	24 V DC	
AMP 12 K4	12 V DC	All valves at the connection block feature 2 terminals whereas the directional spool valve actuators (acc. to D 7700-2 and D 7700-3) show 4 terminals
AMP 24 K4	24 V DC	
For plugs, see pamphlet D 7163		

4. Characteristic data

4.1 General and hydraulic

Type coding	HMPL, HMPV see sect. 3.1
Design	Connection block for combination with up to 12 directional spool valves as valve bank, all-steel design
Mounting	Tapped holes: M8; see dimensions
Installation position	Arbitrary
Ports	P = Pressure inlet (pump) / lead-on R = Return H = Consumer ports M = Pressure gauge connection (pump side) LS = Load sensing pressure port e.g. for pump controller Attention: No pressure input!
Ports	acc. to type and size
Surface coating	All surfaces corrosion-inhibiting, gas nitrided EM solenoids at actuation acc. to D 7490/1
Mass (weight) approx.	size -2: 4.9 kg; size -3: 5.8 kg
Pressure fluid	Hydraulic fluid acc. to DIN 51524 table 1 to 3; ISO VG 10 to 68 acc. to DIN 51519 Viscosity range: min. approx. 4; max. approx. 1500 mm ² /s Optimal operation range: approx. 10...500 mm ² /s Also suitable are biologically degradable pressure fluids of the type HEPG (Polyalkylen-glycol) and HEES (synth. Ester) at operation temperatures up to approx. +70°C. HETG (e.g. rape seed oil) or water based fluids e.g. HFA or HFC must not be used!
Temperature	Ambient: approx. -40 ... +80°C ; Oil: -25 ... +80°C, pay attention to the viscosity range! Start temperature down to -40°C are allowable (Pay attention to the viscosity range during start !), as long as the operation temperature during consequent running is at least 20K higher. Biological degradable pressure fluids: Pay attention to manufacturer's information. With regard to the compatibility with sealing materials do not exceed +70°C. Restrictions with explosion-proof solenoids
Required cleanliness	min. NAS 1638 Classe 8 or ISO 4406 Classe 20/17/14
Operating pressure	P: p _{max} = 250 bar; H: p _{max} = 280 bar; R: p _{max} = 10 bar; End plates E 1, E 2, E 3 etc. with additional leakage port when higher return pressure is anticipated.

4.2 Electrical

Note: Dither and PWM signals are important for optimizing the characteristic and for minimizing the hysteresis

	- Coding V (size 2)	
Add. documentation	D 7490/1 (type EM 31 V)	
Nom. voltage U _N	24 V DC	12 V DC
Nom. power P _N	21 W	21 W
Nom. current I _N	0.63 A	1.2 A

	- Coding PV (size 2) - Coding V (size 3)	
Add. documentation	D 7490/1 (type EMP 31 V, EM 41 V)	
Nom. voltage U _N	24 V DC	12 V DC
Nom. power P _N	32 W	32 W
Nom. current I _N	1.25A	2.5 A

	- Coding PV (size 3)	
Add. documentation	D 7490/1 (type EM 41 V)	
Nom. voltage U _N	24 V DC	12 V DC
Nom. power P _N	30 W	30 W
Nom. current I _N	1.25 A	2.5 A

Circuitry with coding -G 12, -G 24, -X 12, -X 24
EN 175 301-803 A
IP 65 (IEC 60529)

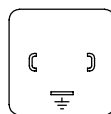

Circuitry with coding -AMP 24
AMP Junior Timer
2-pin
IP 65 (IEC 60529)

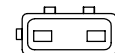

For data of the solenoids for the directional spool valve sections, see D 7700-2 (size 2) or D 7700-3 (size 3)

4.3 Curves

Oil viscosity during measurement approx. 50 mm²/s

Size 2

Pressure limiting valve at the connection block
P → R

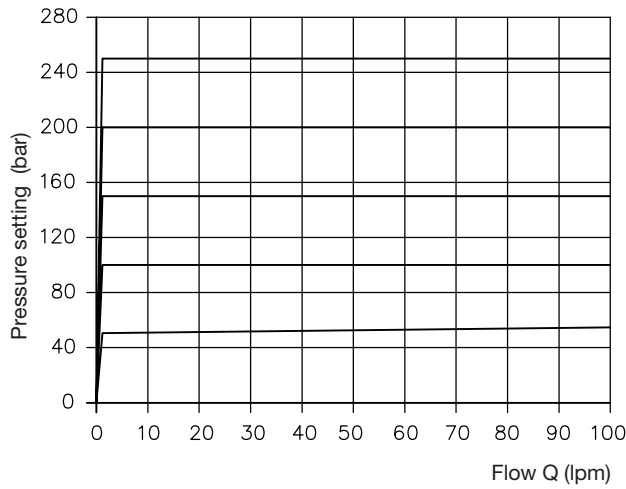

Circulation pressure **P → R**

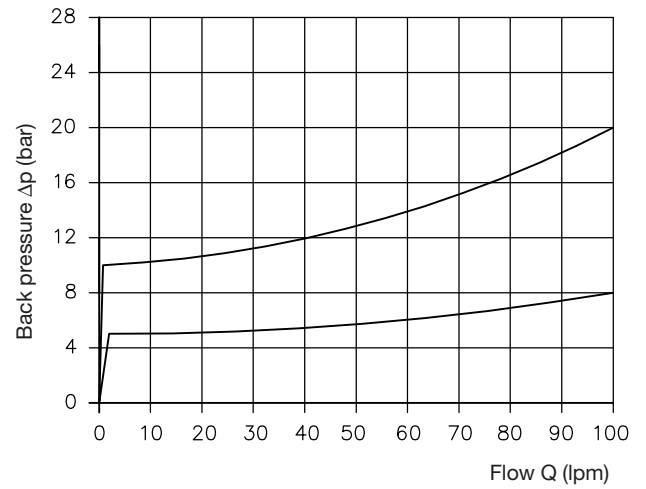

Size 3

Pressure limiting valve at the connection block
P → R

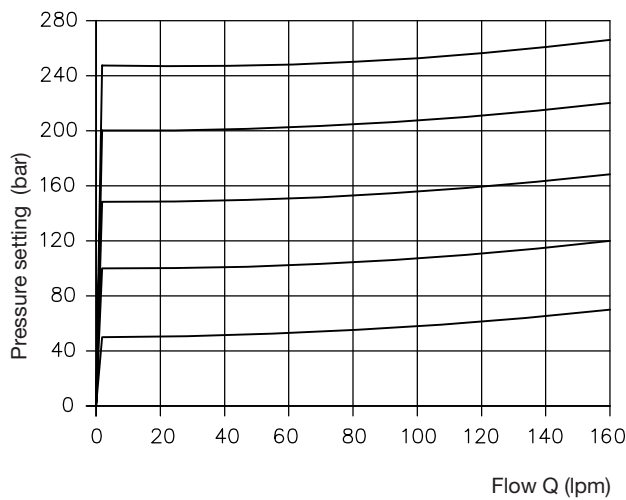

Circulation pressure **P → R**

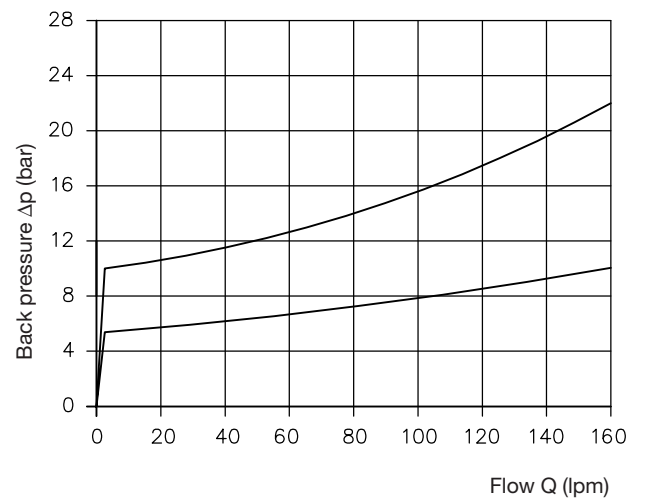

Size 2

Lifting, back pressure (valve 100% open)
P → H

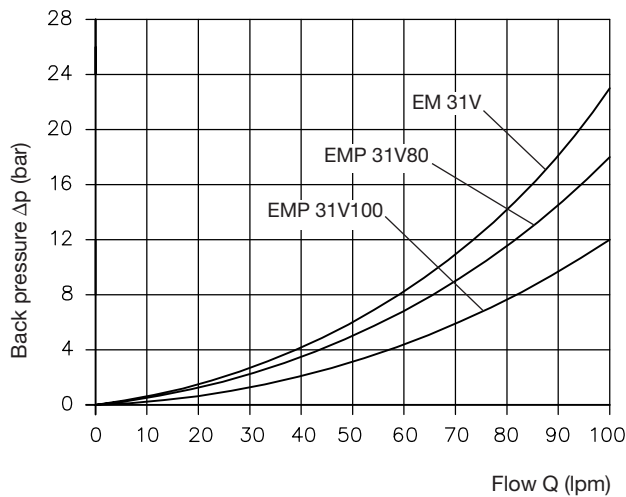

Lowering, back pressure (valve 100% open)
H → R

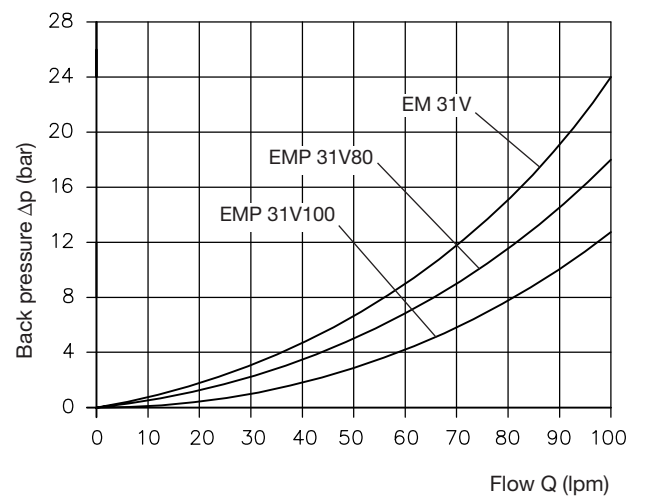

Size 3

Lifting, back pressure (valve 100% open)

P → H

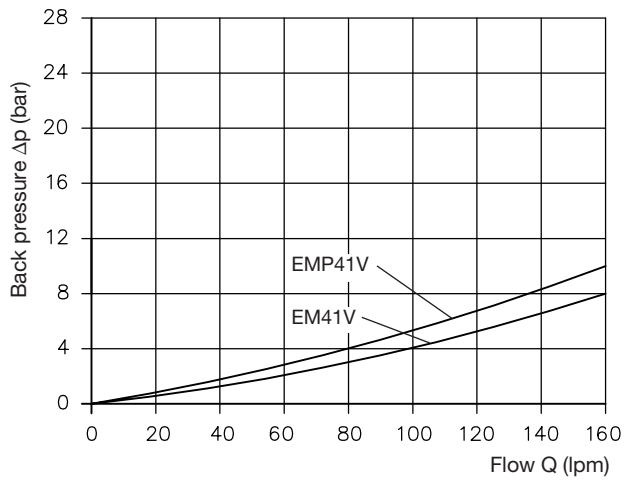

Lowering, back pressure (valve 100% open)

H → R

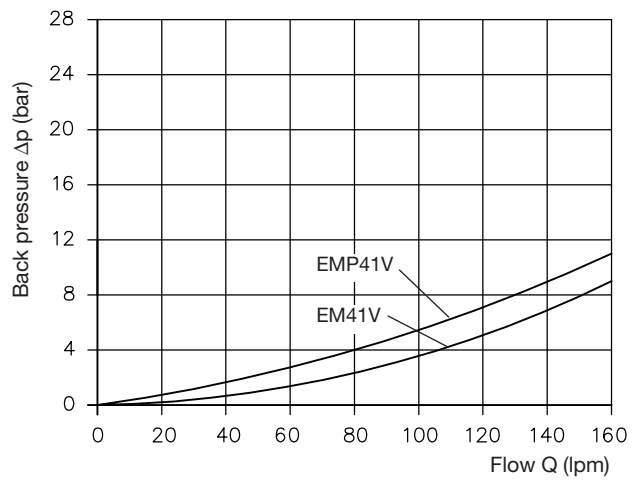

5. Unit dimensions

5.1 Type HMPL/HMPV size 2

All dimensions are in mm and are subject to change without notice!
For additional parameters and dimensions, see sect. 4.1

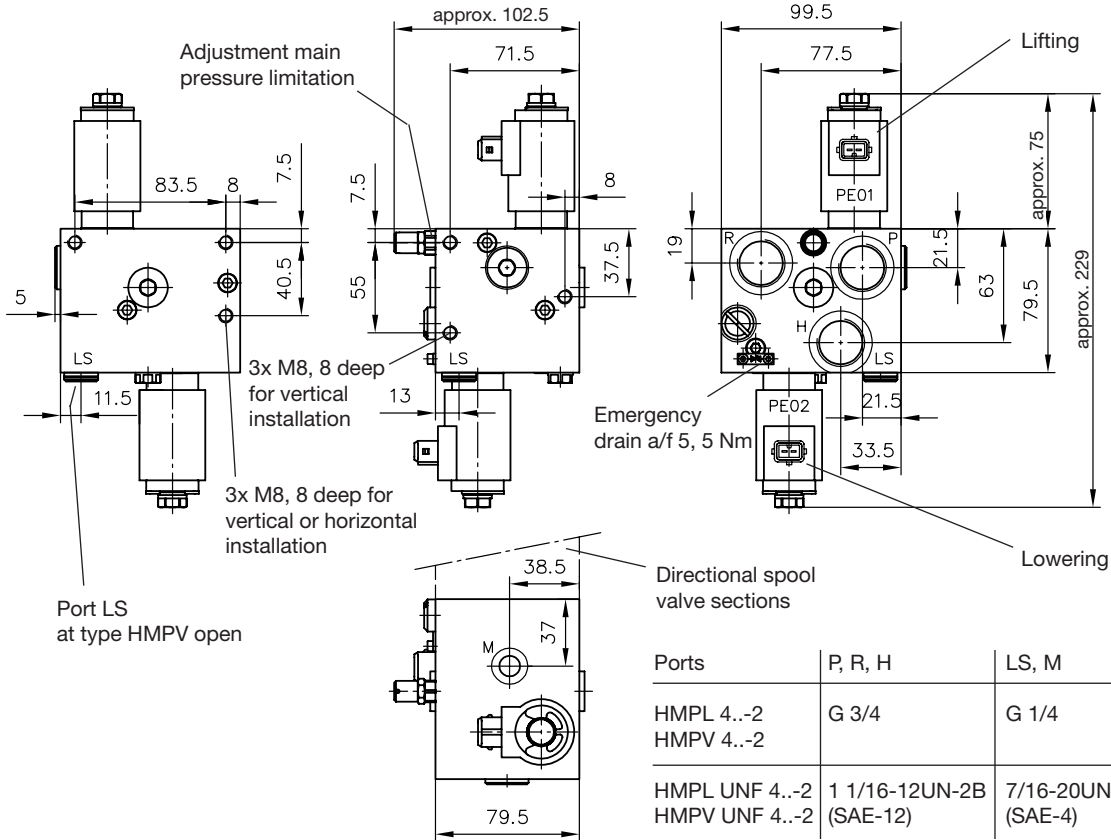

5.2 Type HMPL/HMPV size 3

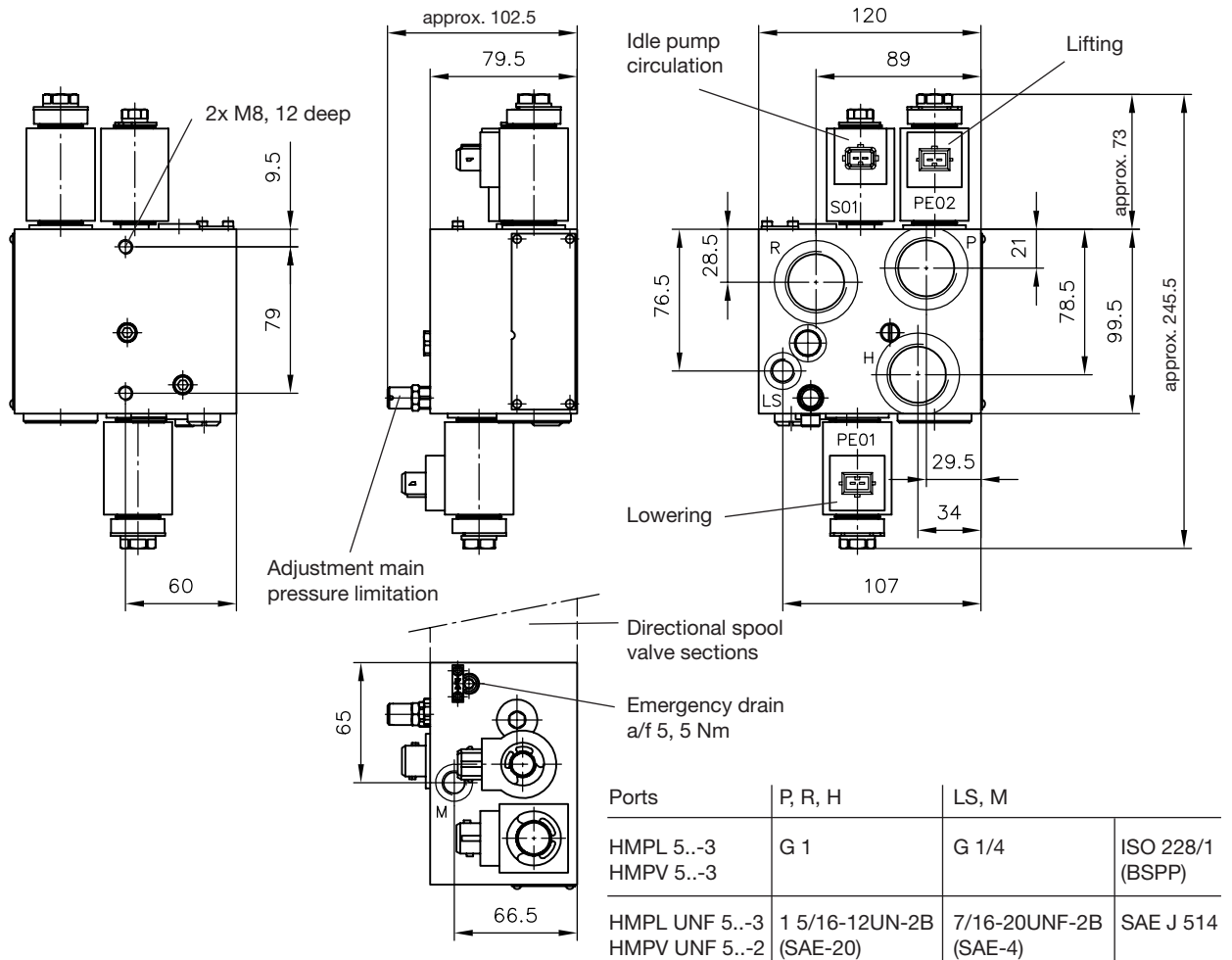

6. Appendix

6.1 Safety notes

It is recommended to employ a line rupture protection valve e.g. type LB acc. to D 6990 to safe guard the lifting device. There is also a version where the line rupture protection valve is designed into a fitting, see SK 6990 E.

Do not operate the connection block without additional dampening element otherwise malfunction of the pressure limiting valve.

It is recommended to employ valves with connection block acc. to D 7490/1 between port H and the lifting cylinder to ensure redundant functional cut-off of the lowering function.

Unintended lifting may occur when the load pressure at H drops below the return pressure at R.

6.2 Transport and storage

1 year (stored packed, dry and cool)

6.3 Installation

The mounting of the valve bank must be performed in such a way that no stress is induced. Screws and washers between valve assembly and bracket are recommended for fastening. Additional mounting at the end plate is recommended for valve banks with more than 4 valve sections.

Note: Observe 6.3 Notes regarding assembly, installation and conversion in pamphlet D 7700-3

6.4 Application example

Counter balance forklift truck with speed controlled electric motor

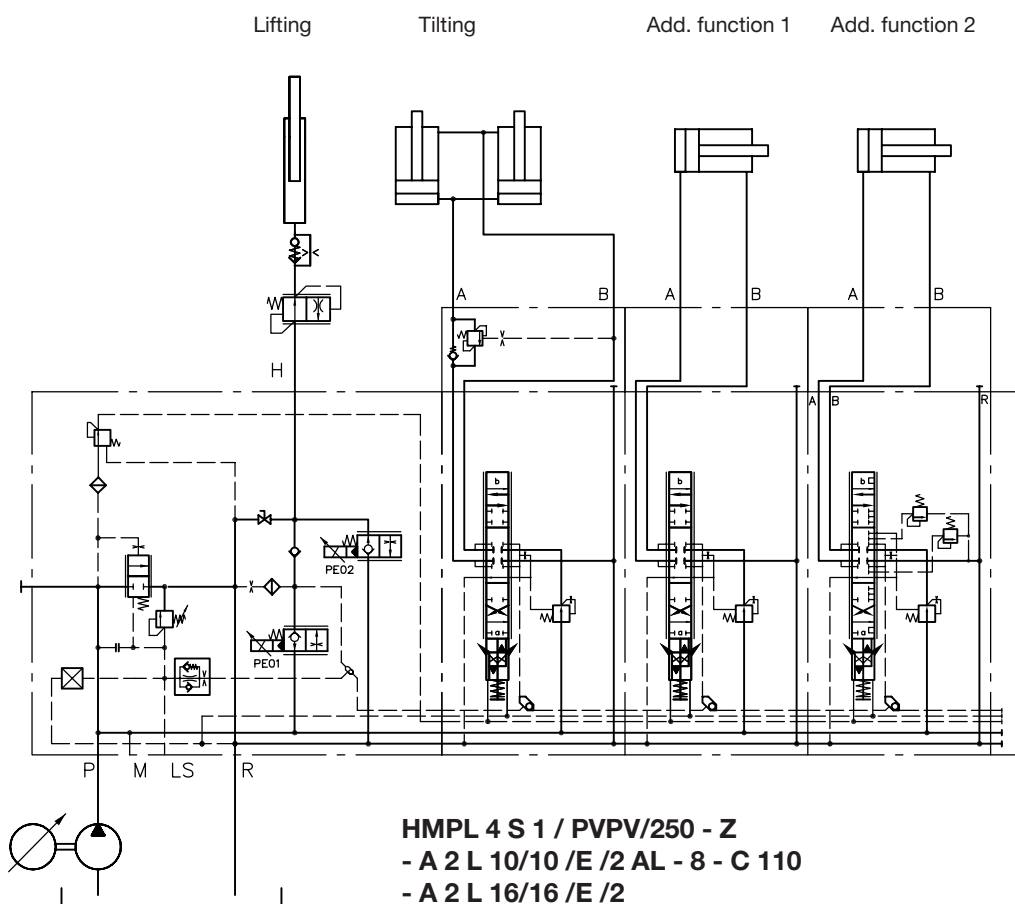

Counter balance forklift truck with internal combustion engine and variable displacement pump electric motor

