

Technical
Information

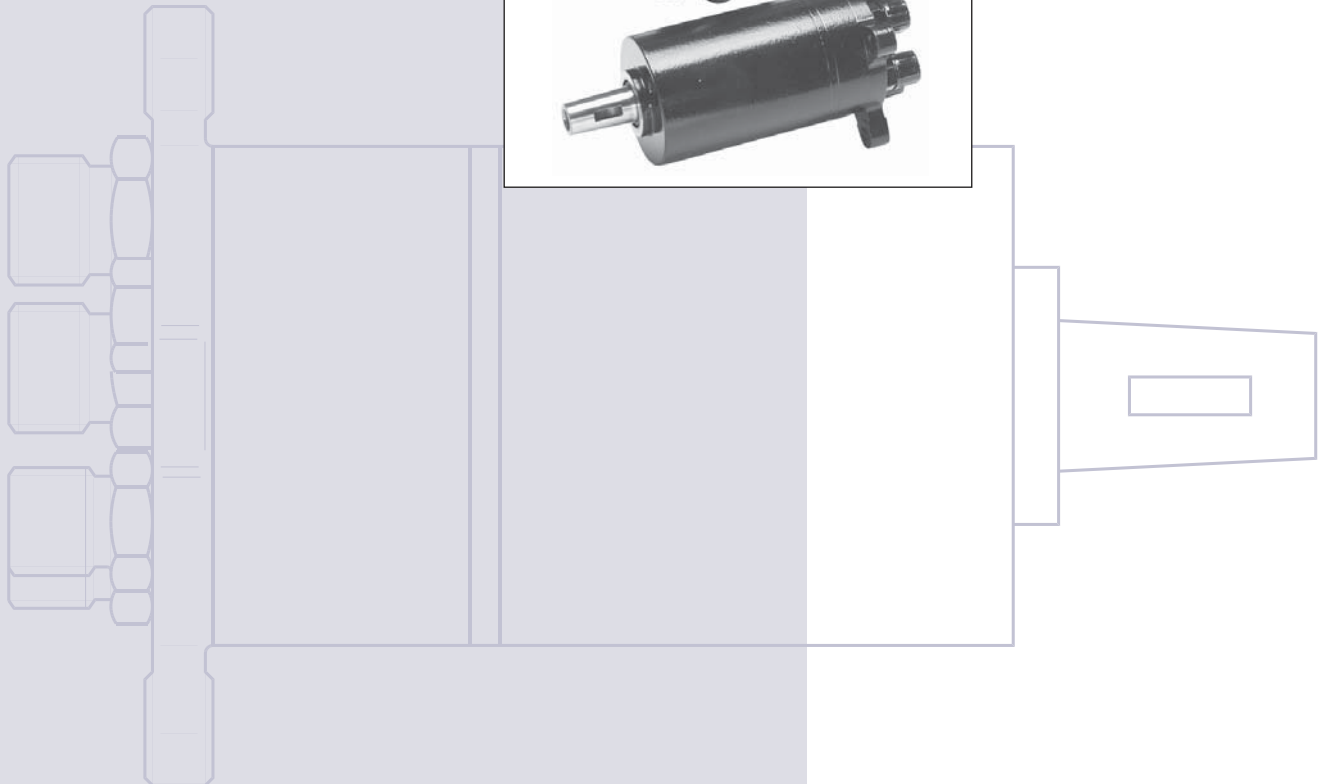
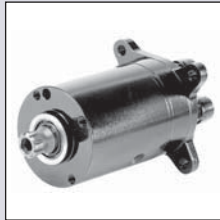

Revision History

Table of Revisions

Date	Page	Changed	Rev
Nov 2009	Many	Steering column deleted	CA
Feb 2010	All	Heading changed	CB

A Wide Range of Steering Components

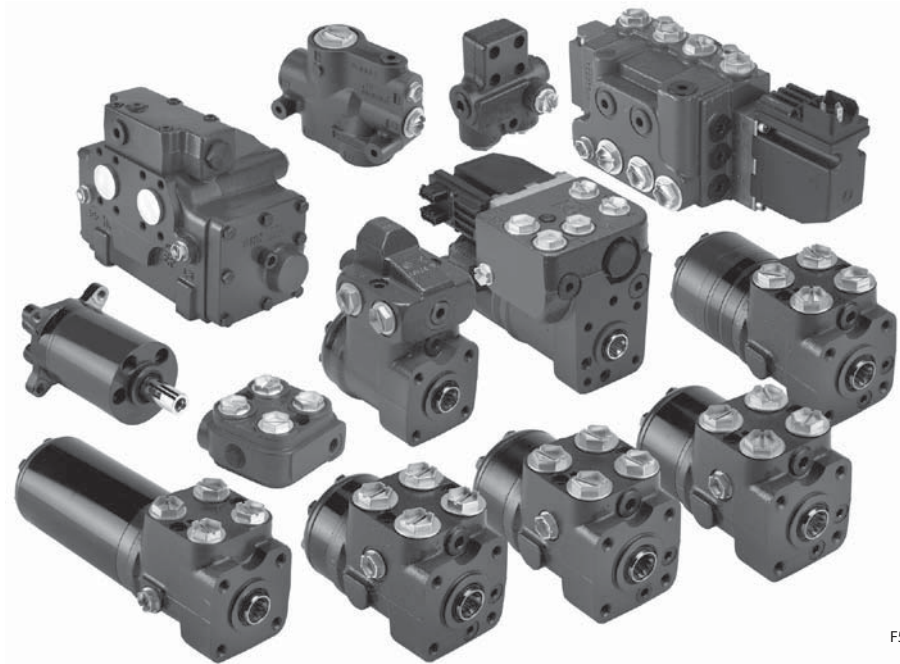

F500 026

Sauer-Danfoss is the largest producer in the world of steering components for hydrostatic steering systems on off-road vehicles. Sauer-Danfoss offer steering solutions both at component and system levels. Our product range makes it possible to cover applications of all types - ranging from ordinary 2-wheel steering (also known as Ackermann steering) to articulated steering, complicated 4-wheel steering, automatic steering (e.g. by sensor) and remote controlled steering via satellite. We can offer more than 1500 different steering units and 250 different priority valves categorized in types, variants and sizes.

T301033

© 2009 Sauer-Danfoss. All rights reserved.

Sauer-Danfoss accepts no responsibility for possible errors in catalogs, brochures and other printed material. Sauer-Danfoss reserves the right to alter its products without prior notice. This also applies to products already ordered provided that such alterations can be made without affecting agreed specifications. All trademarks in this material are properties of their respective owners. Sauer-Danfoss, the Sauer-Danfoss logotype, the Sauer-Danfoss S-icon, PLUS+1™, What really matters is inside® and Know-How in Motion™ are trademarks of the Sauer-Danfoss Group.

Frontpage: P300 015, P300 016, P300 017, P300 019, Pic00016, P300 018, Drawing 151-536

A Wide Range of Steering Components (continued)

For hydrostatic steering systems Sauer-Danfoss offers:

- Mini steering units with displacements from 32 to 100 cm³/rev [1.95 to 6.10 in³/rev], flow up to 20 l/min [5.28 US gal/min], steering pressure up to 125 bar [1813 psi].
- Steering units with displacements from 40 to 1200 cm³/rev [2.44 to 73.2 in³/rev], flow up to 100 l/min [26.4 US gal/min], steering pressure up to 240 bar [3481 psi].
- Priority valves for rated flows at 40, 80, 120, 160 and 320 l/min [10.6, 21.1, 31.7, 42.3 and 84.5 US gal/min], pressure up to 350 bar [5076 psi].
- Pilot operated flow-amplifiers with amplification factors of 4, 5, 8, 10 or 20 for rated oil flows of 240 and 400 l/min [63.4 and 105.7 US gal/min], steering pressure up to 210 bar [3045 psi].
- Pilot operated steering valve with steering flow up to 100 l/min [26.4 US gal/min], steering pressure up to 250 bar [3625 psi] and with integrated priority valve for pump flow up to 120 l/min [31.7 US gal/min].

For electro hydraulic steering systems Sauer-Danfoss offers:

- Pilot operated steering valves (pilot operated by hydrostatic steering unit or by electrical signal) with steering flows up to 100 l/min [26.4 US gal/min], steering pressure up to 250 bar [3625 psi].
- Steering units with integrated electrical operated steering valve with steering flow up to 50 l/min [13.2 US gal/min], steering pressure up to 210 bar [3045 psi].
- Electrical operated steering valves with steering flow up to 40 l/min [10.57 US gal/min], steering pressure up to 210 bar [3045 psi].

Characteristic features for steering units:

- Low steering torque: From 0.5 Nm to 3 Nm in normal steering situations
- Low noise level
- Low pressure drop
- Many types available: Open center None reaction, Open center Reaction, Closed center None reaction, Load Sensing, Load Sensing Reaction
- One or more built-in valve functions: relief valve, shock valves, suction valves, none return valve in P-line and in LS-line
- Optional port connections (according to ISO, SAE or DIN standards)

Characteristic features for electrohydraulic steering system:

- Electrohydraulic steering valve EHPS: High steering pressure requiring smaller cylinders and flow
- EHPS: Low pilot pressure and flow giving extremely low noise in the cabin
- EHPS: The possibility of manual steering even on very heavy vehicles
- EHPS can be combined with Sauer-Danfoss PVG 32 proportional valve
- Minimization of side acceleration with articulated steering
- Possibility of GPS-, row sensor-, joy stick- steering and variable steering ratio

T301034

Conversion Factors

1 N·m	=	[8.851 lbf·in]	1 cm ³	=	[0.061 in ³]
1 N	=	[0.2248 lbf]	1 l	=	[0.264 US gal]
1 bar	=	[14.50 psi]	°F	=	[1.8°C + 32]
1 mm	=	[0.0394 in]			

T301035

Contents

A Wide Range of Steering Components..... 2
 Conversion Factors3
 Survey of Literature with Technical Data on Sauer-Danfoss Steering Components.....5

Steering Unit OSPM..... 6
 Introduction6
 Application6
 Advantages.....6
 Function.....6
 Versions.....7
 OSPM ON7
 OSPM PB.....7
 OSPM LS8
 Code Numbers9
 OSPM Open Center Non-Reaction Steering Units.....9
 OSPM Power Beyond Steering Units10
 OSPM LS Steering Units11
 OSPMS Sideported Steering Units11

Specification Table None Catalogue for Numbers
 of Sauer-Danfoss OSPM Steering Units11

Technical Data12
 Displacement, Flow and PressureOSPM ON/PB.....12
 Displacement, Flow and PressureOSPM LS12
 Manual Steering Pressure13
 Valve Function in OSPMSteering Units13
 Pressure Relief Valve13
 Pilot Pressure Relief Valve14
 Shock Valves.....14
 Check Valve.....14
 Pressure Drop in Neutral.....15
 Port Connections.....15
 Dimensions OSPM.....16

Priority Valves OLS 18
 Versions.....18
 Code Numbers18

Steering Column for OSPM 19
 Load on Integrated Steering Column19
 Load on the Steering Unit Column19
 Installing the Steering Column19

**Survey of Literature
with Technical Data on
Sauer-Danfoss Steering
Components**

Detailed data on all Sauer-Danfoss steering components and accessories can be found in our steering component catalogues, which is divided in to 6 individual sub catalogues:

- General information Steering components
- Technical data on mini steering units OSPM
- Technical data on open center, and closed center steering units OSPB, OSPC, and OSPD
- Technical data on load sensing steering units, priority valves and flow amplifiers OSPB, OSPC, OSPF, OSPD, OSPQ, OSPL, OSPBX, OSPLX, OVPL, OLS and OSQ
- Technical data on hydraulic and electro-hydraulic pilot operated steering valves, electrical actuation modules and appropriate steering units. EHPS, EHPS w. OLS 320, PVE for EHPS and OSPCX
- Technical data on combined steering unit/electro hydraulic steering valves and steering wheel sensors OSPE and SASA

The most important data on all Sauer-Danfoss steering components is highlighted in a general survey brochure.
For technical information on individual variants, please contact the Sauer-Danfoss Sales Organization.

T301036

Introduction

Sauer-Danfoss has marketed mini-steering unit OSPM and the matching steering column OTPM ever since 1995. Positive feedback from the market drives the development and many upratings were introduced to the OSPM-program in the last years. Among these are:

- Introduction of side-ported OSPM versions with 4 and 5 ports in open center non reaction and power beyond variants.
- Introduction of OSPM in a load sensing version. Now available in all standard displacements with valve functions including LS check valve and pilot relief.
- Availability of new neural setting spring packs for optimized steering feel.
- Additional displacements introduced. E.g. new 70 cm³ [4.27 in³] gearset variant plus supplementary valve functions.
- Improved machining process for extra low operational noise level on all OSPM variants.

Application

Examples:

- Minitractors
- Turfcare machines
- Universal tractors
- Forklift trucks
- Municipal vehicles
- ATV's

Advantages

- Small dimensions and low weight
- End ports with integrated fittings
- Easy installation and accessibility
- Possibility of integrated steering column
- Low pressure drop
- Low input torque
- Low system price
- Low noise

Function

OSPM is a hydrostatic steering unit which can be used with an add-on steering column, OTPM/OTPM-T or with the steering column integrated with the unit.

The steering unit consists of a rotary valve and a rotary meter.

Via a steering column or directly the steering unit is connected to the steering wheel of the vehicle. When the steering wheel is turned, oil is directed from the steering system pump via the rotary valve and rotary meter to the cylinder ports L or R, depending on the direction of turn. The rotary meter meters the oil flow to the steering cylinder in proportion to the angular rotation of the steering wheel.

If the oil supply from the steering system pump fails or is too small, the steering unit is able to work as a manual steering pump.

Versions

The mini-steering unit is available in three versions:

- Open-Center Non-Reaction (ON) version, and
- Power Beyond (PB) version where surplus oil can be led to the working hydraulics, and
- Load sensing dynamic versions.

OSPM ON

Open centre steering units have open connection between pump and tank in the neutral position.

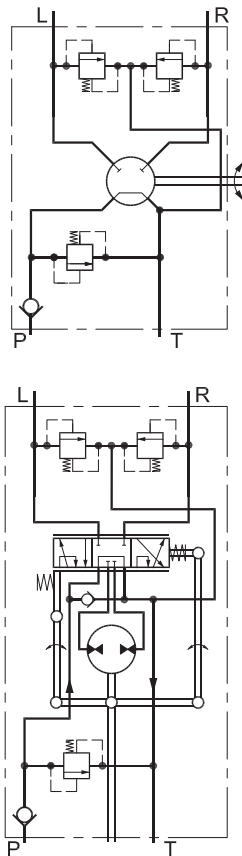

150-539.11

OSPM PB

In Power Beyond steering units the oil from the pump is routed in the neutral position through the steering unit to the E-port.

The steering function always has priority, with any excess oil flow passing through the E port.

If the steering wheel is held at full lock, all flow is led to tank across the pressure relief valve, and flow from the E port will stop.

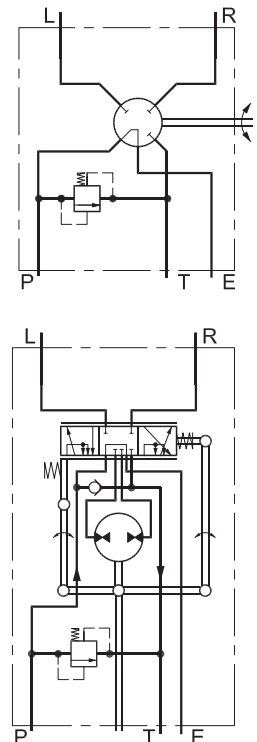

150-540.11

Versions

OSPM LS

In load sensing steering systems both the steering system and the working hydraulics can be supplied with oil from the same pump. The load sensing steering unit works in line with a priority valve and can be connected in parallel with working hydraulics. The priority valve ensures that the steering unit always has priority of supply from the pump before any working hydraulics. Steering input is signalled back to the priority valve and/or a load sense pump through an extra port on the steering unit. The load sense signal controls the oil flow from the priority valve (and/or LS pump). When the steering wheel is in neutral full flow is available for the working hydraulics connected to the excess flow port of the priority valve. All OSPM LS steering units are dynamic type.

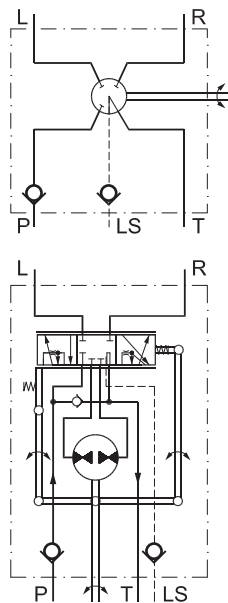

P301 159

Code Numbers

The mini-steering unit is available with displacements of 32, 50, 63, 70, 80 and 100 cm³/rev. [1.95, 3.05, 3.84, 4.27, 4.88 and 6.10 in³/rev.] The check valve for emergency steering is standard in all versions, but optionally, the OSPM can also be fitted with an integrated relief valve and/or a shock valve. Check valve in P port is optional in OSPM rear port versions. Check valve in LS port is standard in all LS versions.

The OSPM is also available with an integrated steering column or alternatively in a version prepared for a flange-on steering column (see page 21).

The connections are integrated endport fittings of the ORFS-type (O-ring face seal). (see page 15). Standard port size is 9/16"-18 UNF

**OSPM
 Open Center
 Non-Reaction Steering
 Units**

Steering unit	Code No. OSPM	Relief valve bar [psi]	Shock valves bar [psi]	Check valve in P-port	Steering wheel connection	Weight kg [lb]
OSPM 32 ON	150L0101	None	None	None	Flanged-on	2.3 [5.1]
OSPM 32 ON	150L2102	None	None	None	Integrated type A	2.3 [5.1]
OSPM 32 ON	150L2103	75-80 [1087-1160]	None	None	Flanged-on	2.3 [5.1]
OSPM 32 ON	150L2104	75-80 [1087-1160]	None	None	Integrated type A	2.3 [5.1]
OSPM 40 ON	150L2079	75-80 [1087-1160]	None	None	Flanged-on	2.4 [5.3]
OSPM 50 ON	150L0111	None	None	None	Flanged-on	2.5 [5.5]
OSPM 50 ON	150L0112	None	None	None	Integrated type A	2.5 [5.5]
OSPM 50 ON	150L0133	None	None	None	Integrated type B	2.5 [5.5]
OSPM 50 ON	150L2113	75-80 [1087-1160]	None	None	Flanged-on	2.5 [5.5]
OSPM 50 ON	150L2114	75-80 [1087-1160]	None	None	Integrated type A	2.5 [5.5]
OSPM 50 ON	150L2150	90-95 [1305-1378]	150-170 [2175-2465]	Yes	Integrated type A	2.5 [5.5]
OSPM 50 ON	150L2132	75-80 [1087-1160]	None	None	Integrated type B	2.5 [5.5]
OSPM 63 ON	150L0142	75-80 [1087-1160]	None	None	Flanged-on	2.6 [5.7]
OSPM 63 ON	150L0143	75-80 [1087-1160]	None	None	Integrated type A	2.6 [5.7]
OSPM 63 ON	150L0144	75-80 [1087-1160]	None	None	Integrated type B	2.6 [5.7]
OSPM 80 ON	150L0121	None	None	None	Flanged-on	2.7 [5.9]
OSPM 80 ON	150L0122	None	None	None	Integrated type A	2.7 [5.9]
OSPM 80 ON	150L0137	None	None	None	Integrated type B	2.7 [5.9]
OSPM 80 ON	150L2123	75-80 [1087-1160]	None	None	Flanged-on	2.7 [5.9]
OSPM 80 ON	150L2124	75-80 [1087-1160]	None	None	Integrated type A	2.7 [5.9]
OSPM 80 ON	150L2136	75-80 [1087-1160]	None	None	Integrated type B	2.7 [5.9]
OSPM 100 ON	150L0154	75-80 [1087-1160]	None	None	Flanged-on	2.9 [6.4]
OSPM 100 ON	150L0155	75-80 [1087-1160]	None	None	Integrated type A	2.9 [6.4]
OSPM 100 ON	150L0156	75-80 [1087-1160]	None	None	Integrated type B	2.9 [6.4]

Code Numbers

**OSPM
 Power Beyond Steering
 Units**

Steering unit	Code No. OSPM	Relief valve bar [psi]	Shock valves bar [psi]	Check valve in P-port	Steering wheel connection	Weight kg [lb]
OSPM 32 PB	150L0105	None	None	None	Flanged-on	2.6 [5.7]
OSPM 32 PB	150L2106	None	None	None	Integrated type A	2.6 [5.7]
OSPM 32 PB	150L0107	75-80 [1087-1160]	None	None	Flanged-on	2.6 [5.7]
OSPM 32 PB	150L2108	75-80 [1087-1160]	None	None	Integrated type A	2.6 [5.7]
OSPM 50 PB	150L0115	None	None	None	Flanged-on	2.8 [6.2]
OSPM 50 PB	150L0116	None	None	None	Integrated type A	2.8 [6.2]
OSPM 50 PB	150L0135	None	None	None	Integrated type B	2.8 [6.2]
OSPM 50 PB	150L2117	75-80 [1087-1160]	None	None	Flanged-on	2.8 [6.2]
OSPM 50 PB	150L2118	90-95 [1305-1378]	None	None	Integrated type A	2.8 [6.2]
OSPM 50 PB	150L0134	75-80 [1087-1160]	None	None	Integrated type B	2.8 [6.2]
OSPM 63 PB	150L0163	75-80 [1087-1160]	None	None	Flanged-on	2.9 [6.4]
OSPM 63 PB	150L0164	75-80 [1087-1160]	None	None	Integrated type A	2.9 [6.4]
OSPM 63 PB	150L0165	75-80 [1087-1160]	None	None	Integrated type B	2.9 [6.4]
OSPM 80 PB	150L0125	None	None	None	Flanged-on	3.0 [6.6]
OSPM 80 PB	150L0126	None	None	None	Integrated type A	3.0 [6.6]
OSPM 80 PB	150L0139	None	None	None	Integrated type B	3.0 [6.6]
OSPM 80 PB	150L0127	75-80 [1087-1160]	None	None	Flanged-on	3.0 [6.6]
OSPM 80 PB	150L2128	75-80 [1087-1160]	None	None	Integrated type A	3.0 [6.6]
OSPM 80 PB	150L0138	75-80 [1087-1160]	None	None	Integrated type B	3.0 [6.6]
OSPM 100 PB	150L0160	75-80 [1087-1160]	None	None	Flanged-on	3.2 [7.1]
OSPM 100 PB	150L0161	75-80 [1087-1160]	None	None	Integrated type A	3.2 [7.1]
OSPM 100 PB	150L0162	75-80 [1087-1160]	None	None	Integrated type B	3.2 [7.1]

If you wish other valve combinations or valve settings please fill in the order form on page 11 and contact the Sauer-Danfoss Sales Organisation.

Code Numbers

**OSPM LS
 Steering Units**

Steering unit	Code No.	Relief valve bar [psi]	Shock valves bar [psi]	Check valve in P-port	Check valve in LS-Port	Steering wheel connection	Weight kg [lb]
OSPM 63 LS	11059674	75-80 [1087-1160]	None	Yes	Yes	Flanged-on	2.9 [6.4]
OSPM 63 LS	11059675	75-80 [1087-1160]	None	Yes	Yes	Integrated type A	2.9 [6.4]
OSPM 63 LS	11059676	75-80 [1087-1160]	None	Yes	Yes	Integrated type B	2.9 [6.4]
OSPM 80 LS	11059680	75-80 [1087-1160]	None	Yes	Yes	Flanged-on	3.0 [6.6]
OSPM 80 LS	11059681	75-80 [1087-1160]	None	Yes	Yes	Integrated type A	3.0 [6.6]
OSPM 80 LS	11059682	75-80 [1087-1160]	None	Yes	Yes	Integrated type B	3.0 [6.6]
OSPM 100 LS	11059683	75-80 [1087-1160]	None	Yes	Yes	Flanged-on	3.2 [7.1]
OSPM 100 LS	11059684	75-80 [1087-1160]	None	Yes	Yes	Integrated type A	3.2 [7.1]
OSPM 100 LS	11059685	75-80 [1087-1160]	None	Yes	Yes	Integrated type B	3.2 [7.1]

If you wish other valve combinations or valve settings, please fill in the order below and contact the Sauer-Danfoss Sales Organisation.

Code Numbers

**OSPMS Sideported
 Steering Units**

Steering unit	Code No.	Relief valve bar [psi]	Shock valves bar [psi]	Check valve in P-port	Check valve in LS-Port	Steering wheel connection	Weight kg [lb]
OSPM S 63 ON	11059686	75-80 [1087-1160]	None	None	Yes	Flanged-on	2.8 [6.2]
OSPM S 100 ON	11059689	75-80 [1087-1160]	None	None	Yes	Flanged-on	3.1 [6.8]
OSPM S 63 PB	11059690	75-80 [1087-1160]	None	None	Yes	Flanged-on	3.2 [7.1]
OSPM S 100 PB	11059693	75-80 [1087-1160]	None	None	Yes	Flanged-on	3.5 [7.7]

**Specification Table
 None Catalogue for
 Numbers of Sauer-
 Danfoss OSPM Steering
 Units**

Your company	Name	Vehicle	Potential, pcs/year	Completed by	Date		
Steering unit type	OSPM ON		OSPM PB		OSPM LS		
DP* cm ³ /rev [in ³ /rev]	32 [1.95]	40 [2.44]	50 [3.05]	60 [3.84]	70 [4.27]	80 [4.88]	100 [6.10]
OSPM							
Rear ports P, T, E/LS	9/16"-18 UNF ORFS		11/16"-16 UNF ORFS		G 1/4"-30 flare		
Rear Ports L, R	9/16"-18 UNF ORFS		11/16"-16 UNF ORFS		G 1/4"-30 flare		
Side ports P, T, E/LS	9/16"-18 UNF		11/16"-16 UNF		M 14 x 1.5		
Side ports L,R	9/16"-18 UNF		11/16"-16 UNF		M 14 x 1.5		
RV** bar [psi]	75 [1087]	80 [1160]	90 [1305]	100 [1450]	110 [1595]	125 [1812]	No relief
Shock valves bar [psi]	130 [1885]	140 [2030]	150 [2175]	160 [2320]	170 [2610]	185 [2683]	No shock valves
Check valve in P-line	YES			NO			

DP* = Displacement RV** = Pressure relief valve

An alternativ way to specify a variant is to statean existing code number and add the modifications, you would like to have in the basic steering unit.

Code number of basic steering unit: _____

Requested modifications: _____

Technical Data

Common data:

Look in sub catalogue: "General Steering Components" page 28

Displacement, Flow and Pressure OSPM ON/PB

Steering unit	Displacement cm ³ /rev [in ³ /rev]	Recommended* oil flow l/min [US gal/min]	Max pressure on connections			
			P bar [psi]	T bar [psi]	L, R bar [psi]	E bar [psi]
OSPM 32 ON	32 [1.95]	3-9 [0.8-2.4]	125 [1813]	20 [290]	180 [2610]	-
OSPM 40 ON	40 [2.44]	4-12 [1.1-3.2]	125 [1813]	20 [290]	180 [2610]	-
OSPM 50 ON	50 [3.05]	5-15 [1.3-4.0]	125 [1813]	20 [290]	180 [2610]	-
OSPM 63 ON	63 [3.84]	6-18 [1.6-4.8]	125 [1813]	20 [290]	180 [2610]	-
OSPM 70 ON	70 [4.27]	7-20 [1.9-5.3]	125 [1813]	20 [290]	180 [2610]	-
OSPM 80 ON	80 [4.88]	7-20 [1.9-5.3]	125 [1813]	20 [290]	180 [2610]	-
OSPM 100 ON	100 [6.10]	7-20 [1.9-5.3]	125 [1813]	20 [290]	180 [2610]	-
OSPM 32 PB	32 [1.95]	3-20 [0.8-5.3]	125 [1813]	20 [290]	180 [2610]	125 [1813]
OSPM 40 PB	40 [2.44]	4-20 [1.1-5.3]	125 [1813]	20 [290]	180 [2610]	125 [1813]
OSPM 50 PB	50 [3.05]	5-20 [1.3-5.3]	125 [1813]	20 [290]	180 [2610]	125 [1813]
OSPM 63 PB	63 [3.84]	6-20 [1.6-5.3]	125 [1813]	20 [290]	180 [2610]	125 [1813]
OSPM 70 PB	70 [4.27]	7-20 [1.9-5.3]	125 [1813]	20 [290]	180 [2610]	125 [1813]
OSPM 80 PB	80 [4.88]	7-20 [1.9-5.3]	125 [1813]	20 [290]	180 [2610]	125 [1813]
OSPM 100 PB	100 [6.10]	7-20 [1.9-5.3]	125 [1813]	20 [290]	180 [2610]	125 [1813]

* Criteria for determining the recommended oil flow:

- Must minimum be the oil flow it takes to ensure sufficient steering speed at idle motor speed
- Must ensure the least possible pressure loss at full speed

The steering unit can cope with an oil flow that is up to 50% higher than the maximum recommended value.

Displacement, Flow and Pressure OSPM LS

Steering unit	Displacement cm ³ /rev [in ³ /rev]	Rated oil flow* l/min [US gal/min]	Max pressure on connections			
			P bar [psi]	T bar [psi]	L, R bar [psi]	LS bar [psi]
OSPM 32 LS	32 [1.95]	3 [0.79]	125 [1813]	20 [290]	180 [2610]	125 [1813]
OSPM 40 LS	40 [2.44]	4 [1.06]	125 [1813]	20 [290]	180 [2610]	125 [1813]
OSPM 50 LS	50 [3.05]	5 [1.32]	125 [1813]	20 [290]	180 [2610]	125 [1813]
OSPM 63 LS	63 [3.84]	6 [1.58]	125 [1813]	20 [290]	180 [2610]	125 [1813]
OSPM 70 LS	70 [4.27]	7 [1.85]	125 [1813]	20 [290]	180 [2610]	125 [1813]
OSPM 80 LS	80 [4.88]	8 [2.11]	125 [1813]	20 [290]	180 [2610]	125 [1813]
OSPM 100 LS	100 [6.10]	10 [2.64]	125 [1813]	20 [290]	180 [2610]	125 [1813]

Manual Steering Pressure

Under normal operating where the steering pump supplies an adequate oil flow at the required pressure, the maximum torque on the steering wheel will not exceed 2 Nm [17.7 lbf-in]. If the oil flow from the steering system pump fails or is too small, the steering unit functions automatically as a manual steering pump. Manual steering can only be used for a limited control of the vehicle if a sudden drop of pump pressure occurs.

The table below shows the manual steering pressure (P_m) for all sizes of Sauer-Danfoss steering units type OSPM at a steering wheel torque of 80 Nm [708 lbf-in].

The values apply only if the suction conditions on the steering unit T port are adequate.

OSPM		32	40	50	63	80	100
P_m	bar	100	90	80	60	50	40
	[psi]	[1450]	[1305]	[1160]	[870]	[725]	[580]

Valve Function in OSPM Steering Units

The data below comes from measurements on a representative sample of steering unit from production. Oil with a viscosity of 21 mm²/s [100 SUS] at 50°C [122°F] was used during measuring.

Pressure Relief Valve

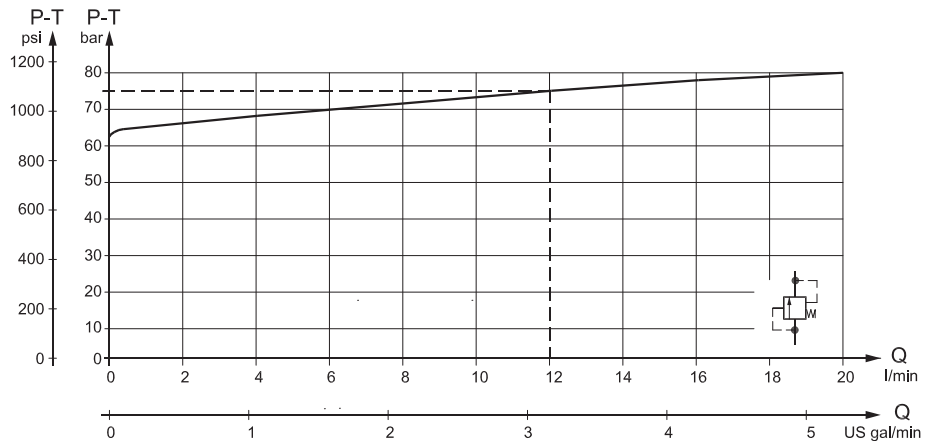

150-507.10

The pressure relief valve protects the pump and steering unit against excess pressure and limits the system pressure while steering.

The pressure relief valve in the steering unit will limit the maximum pressure drop from P to T.

The pressure relief valve is set at 12 l/min [3.17 US gal/min] flow.

Pilot Pressure Relief Valve

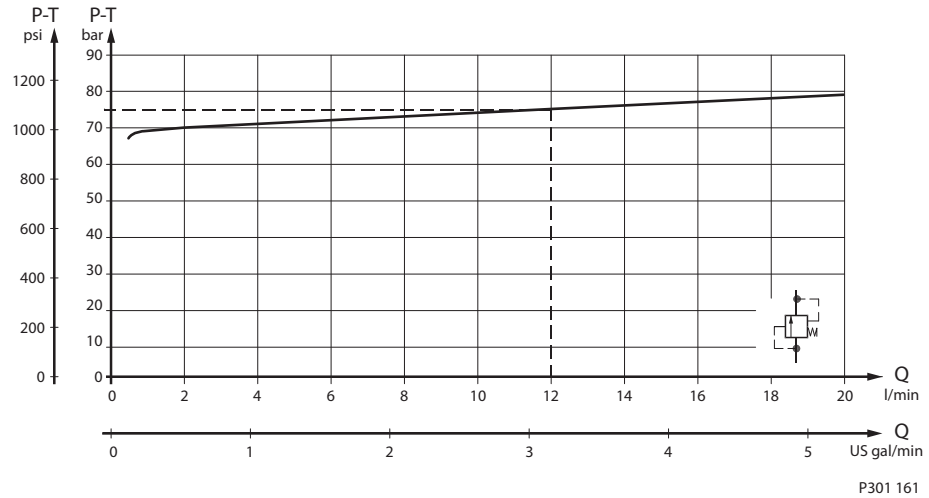

The pilot pressure relief valve together with the priority valve limits the maximum steering pressure P-T. The pilot pressure relief valve is set at an oil flow to the priority valve of 12 l/min [3.17 US gal/min]. For the OSPM LS load sensing dynamic steering units, the setting values are valid at a dynamic flow of 0.6 l/min [0.16 US gal/min].

Shock Valves

The shock valves protect the steering unit against shocks from external forces on the steering cylinder. The shock valves in the steering unit limit the max pressure drop from L to T and from R to T. The shock valves are set at 1 l/min [0.27 US gal/min]. They are of the direct type and therefore have a very quick reaction. The setting tolerance is +20 bar [+290 psi].

Check Valve

The check valve protects the driver against kickbacks in the steering wheel. It prevents the oil from flowing back into the pump line during steering under high pressure on the cylinder side. The check valve is mounted in the P-connection of the steering unit.

Pressure Drop in Neutral

The pressure drop is measured with the steering unit in neutral position.
 On the OSPM ON the pressure drop is measured from P to T.
 On the OSPM PB the pressure drop is measured from P to E.
 The following values are valid at an oil temperature of 50 °C [122 °F] for rear ported units
 and at a viscosity of 21 mm²/S [100 SUS]

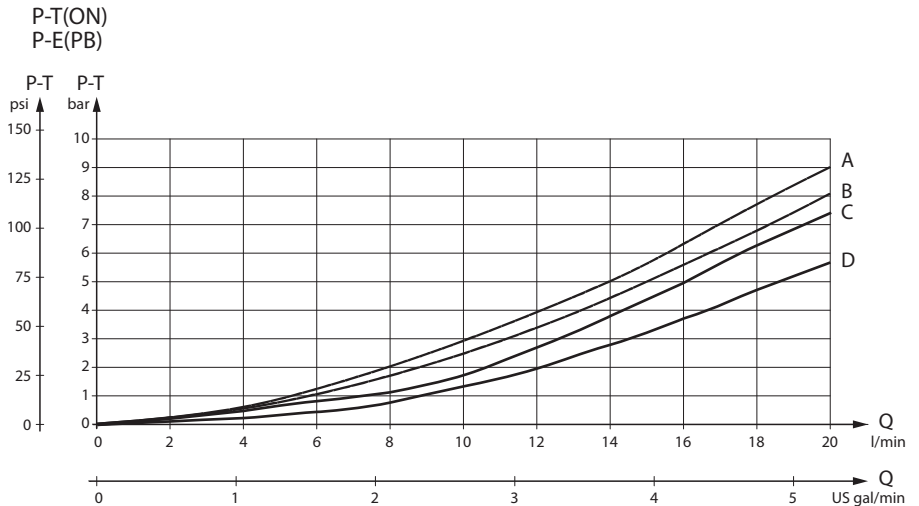

- A: OSPM 32 ON + all PB C: OSPMS PB
 B: OSPM 50-100 ON D: OSPMS ON

P301 141

Port Connections

The connections of all rear ported OSPM-steering units in the catalogue are 9/16-18 UNF of the O-ring face seal type (ORFS).

The integrated end port fittings are specially developed for OSPM and therefore easily interchangeable.

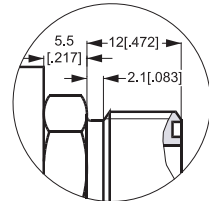

150-480.10

Dimensions of O-rings for 9/16-18 UNF ORFS ports:
 7.65 × 1.78 mm [3.02 × 0.702 in] (SAE J515 seal size no. 011).

Set of seals Sauer-Danfoss code no. 150L4042 contains 5 pcs. of these O-rings.

The standard port size for all sideported OSPM versions in this catalogue is 9/16-18 UNF
 Units are also available with M 14 × 1.5 : ISO 6149-1

Dimensions OSPM

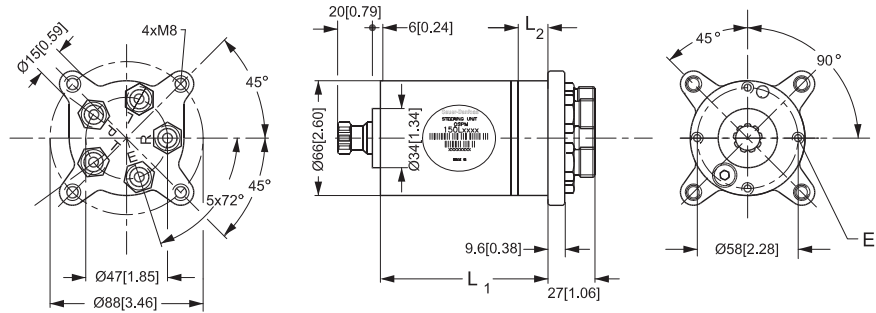

E: 4 × M6, 11 mm [0.432 in] deep

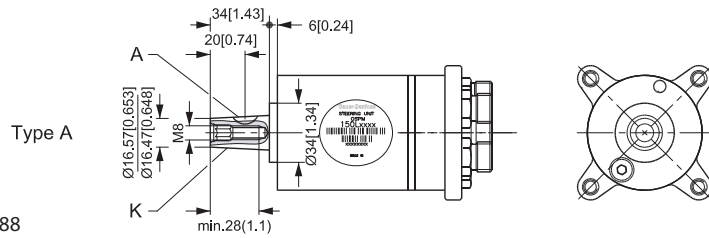

A: 5 × 6.5 DIN 6888
 K: Taper 1:20

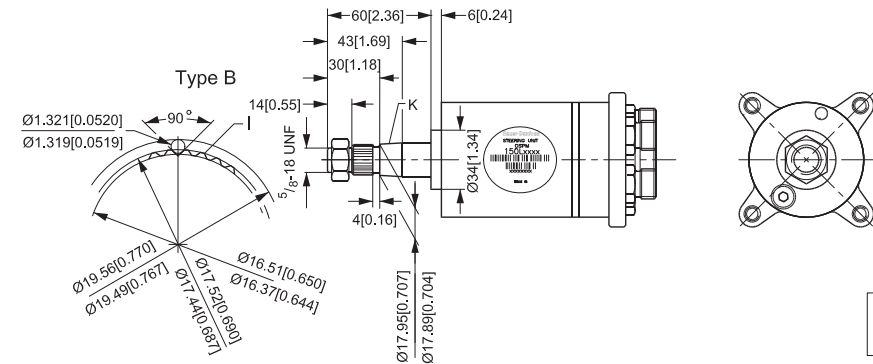

With 1/16 in-40 serrations
 $d_{min} = 17.92 \text{ mm [0.72 in]}$
 K: Taper 1:12

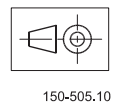

Mini Steering Unit	L1 mm	[in]	L2 mm	[in]
OSPM 32 ON	90	[3.54]	11.0	[0.43]
OSPM 40 ON	93	[3.66]	13.7	[0.54]
OSPM 50 ON	96	[3.78]	17.1	[0.67]
OSPM 63 ON	100	[3.94]	21.6	[0.85]
OSPM 70 ON	103	[4.05]	24.0	[0.94]
OSPM 80 ON	106	[4.17]	27.4	[1.08]
OPSM 100 ON	113	[4.45]	34.2	[1.35]
OSPM 32 PB/LS	103	[4.06]	11.0	[0.43]
OSPM 50 PB/LS	109	[4.29]	17.1	[0.67]
OSPM 63 PB/LS	113	[4.45]	21.6	[0.85]
OSPM 70 PB/LS	116	[4.57]	24.0	[0.94]
OSPM 80 PB/LS	119	[4.69]	27.4	[1.08]
OSPM 100 PB/LS	126	[4.96]	34.2	[1.35]

Dimensions OSPMS

E: 4xM6.11mm [0.432 in] deep

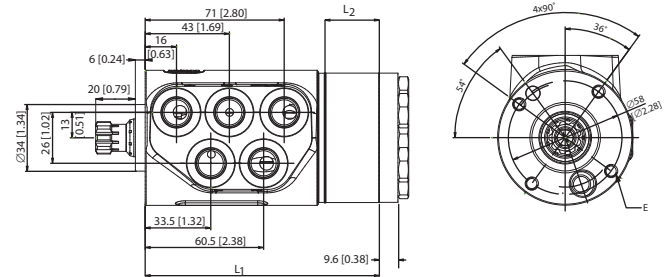

Type A

A: 5x6.5 DIN 6888
 K: Taper 1:20

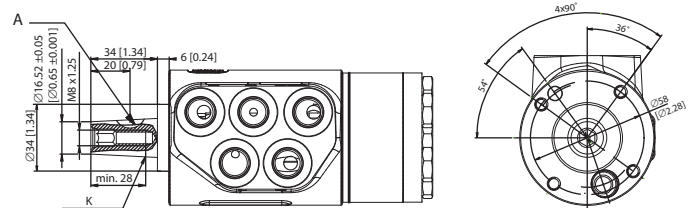

Type B

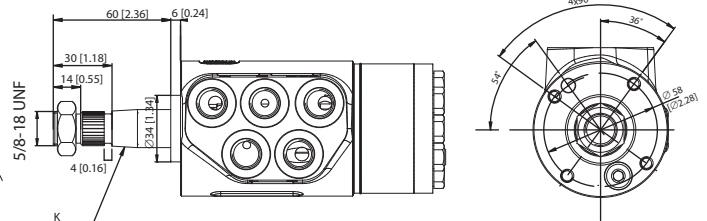
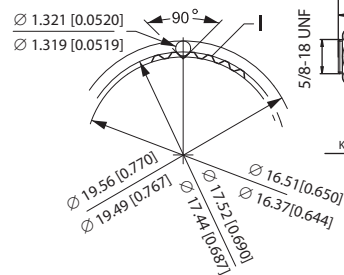

P301 150

With $\frac{1}{16}$ in-40 serrations
 $d_{min} = 17.92 \text{ mm [0.72 in]}$
 K: Taper 1:12

Sideported versions available

Mini Steering Unit	L1 mm	[in]	L2 mm	[in]
OSPMS 63 ON	100	[3.94]	21.6	[0.85]
OSPMS 80 ON	106	[4.17]	27.4	[1.08]
OSPMS 100 ON	113	[4.45]	34.2	[1.35]
OSPMS 63 PB	113	[4.45]	21.6	[0.85]
OSPMS 80 PB	119	[4.69]	27.4	[1.08]
OSPMS 100 PB	126	[4.96]	34.2	[1.35]

Priority valves OLS

The Sauer-Danfoss priority valves type OLS can be used in load sensing steering systems together with OSPM LS steering units.

Versions

All OSPM LS are dynamic types.
 Load sensing dynamic steering units require load sensing dynamic priority valves. Load sensing dynamic steering systems have a constant oil flow in the LS connection from the priority valve to the steering unit even when the steering unit is in neutral position.

Examples

The OLS 40/80 and OLSP 80 priority valve can be used with OSPM LS steering units.

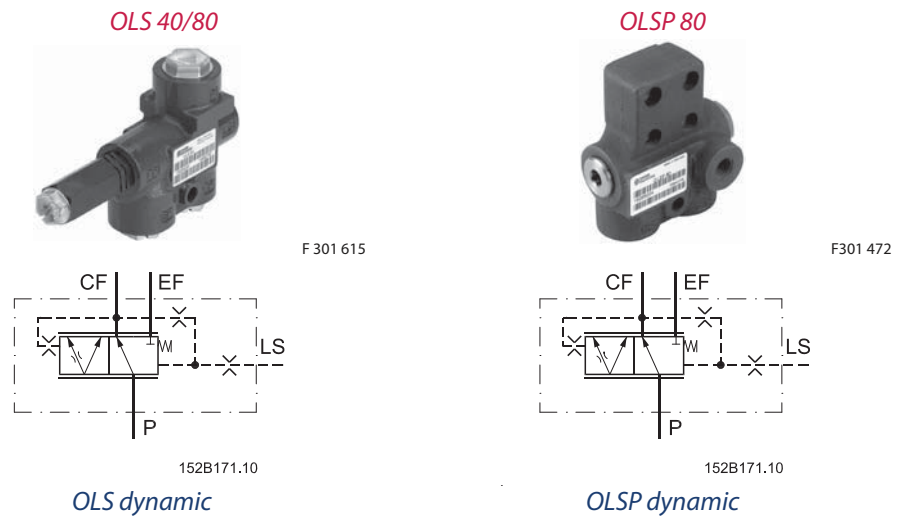

Code Numbers

OLS 40 and OLS 80 dynamic priority valves

Priority valve	Code Numbers		Control spring pressure bar [psi]	Weight kg [lb]
	Connections			
	European version LS: G 1/4 P, EF, CF: G 1/2	US version LS: 7/16 -20 UNF CF: 3/4 - 16 UNF P, EF: 7/8 - 14 UNF		
OLS 40	152B8231	-	4 [58]	1.0 [2.2]
OLS 40	152B8232	152B8253	7 [101.5]	1.0 [2.2]
OLS 40	152B8233	152B8254	10 [145]	1.0 [2.2]
OLS 80	152B8261	-	4 [58]	1.0 [2.2]
OLS 80	152B8256	152B8268	7 [101.5]	1.0 [2.2]
OLS 80	152B8257	152B8260	10 [145]	1.0 [2.2]

OLSP dynamic priority valve

Priority valve	Code Numbers		Control spring pressure bar [psi]	Weight kg [lb]
	Connections			
	European version LS: G 1/4, CF: G 3/8, EF: G 1/2			
OLSP 80	152B5200		7 [101.5]	1.0 [2.2]

Please refer to the Sauer-Danfoss catalogue . OSPB, OSPC, OSPF, OSPD, OSPQ, OSPL, Load Sensing Steering Units - Technical Information for more information on available priority valves.

Load on Integrated Steering Column

Symbols:
 L (m/in): Axial length between OSPM housing and steering wheel
 F_r (N/lb): Radial force on steering wheel
 F_a (N/lb): Axial force on steering wheel
 M_B (Nm/lbf·in): Bending moment on steering column $M_B = F_r \cdot L$

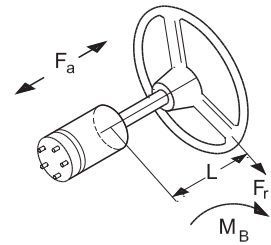

150-477.10

The following max. permissible values must not be exceeded:

M_B max.: 50 Nm [438 lbf·in]
 F_r max: 500 N [112 lb]
 F_a max: 600 N [135 lb]

With a given length L the max. force F_r on the steering wheel can be calculated:

$$F_r = \frac{M_B \text{ max}}{L + 0.015} \quad \text{N; } L \text{ in m}$$

$$F_r = \frac{M_B \text{ max}}{L + 0.590} \quad \text{lb; } L \text{ in inch}$$

Load on the Steering Unit Column

The construction of the steering column must ensure that no axial or radial forces are transferred to the steering unit.
 Such forces may prevent the steering unit from returning to neutral position automatically after a steering action has been completed.

Installing the Steering Column

Max. tightening torque for fixing screws: 10^{+3}_{-0} Nm [88^{+27}_{-0} lbf·in]

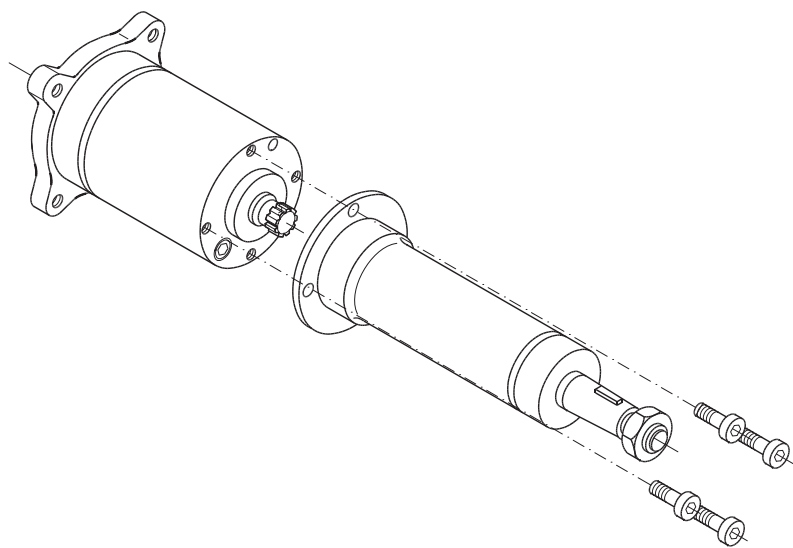

150-604.10



Our Products

Open circuit axial piston pumps
Gear pumps and motors
Fan drive systems
Closed circuit axial piston pumps and motors
Bent axis motors
Hydrostatic transmissions
Transit mixer drives
Hydrostatic transaxles
Electrohydraulics
Integrated systems
Microcontrollers and software
PLUS+1™ GUIDE
Displays
Joysticks and control handles
Sensors
Orbital motors
Inverters
Electrohydraulic power steering
Hydraulic power steering
Hydraulic integrated circuits (HIC)
Cartridge valves
Directional spool valves
Proportional valves

Sauer-Danfoss Mobile Power and Control Systems – Market Leaders Worldwide

Sauer-Danfoss is a comprehensive supplier providing complete systems to the global mobile market.

Sauer-Danfoss serves markets such as agriculture, construction, road building, material handling, municipal, forestry, turf care, and many others.

We offer our customers optimum solutions for their needs and develop new products and systems in close cooperation and partnership with them.

Sauer-Danfoss specializes in integrating a full range of system components to provide vehicle designers with the most advanced total system design.

Sauer-Danfoss provides comprehensive worldwide service for its products through an extensive network of Global Service Partners strategically located in all parts of the world.

Local address:

Sauer-Danfoss (US) Company
2800 East 13th Street
Ames, IA 50010, USA
Phone: +1 515 239-6000
Fax: +1 515 239 6618

Sauer-Danfoss ApS
DK-6430 Nordborg, Denmark
Phone: +45 7488 4444
Fax: +45 7488 4400

Sauer-Danfoss GmbH & Co. OHG
Postfach 2460, D-24531 Neumünster
Krokamp 35, D-24539 Neumünster, Germany
Phone: +49 4321 871-0
Fax: +49 4321 871 122

Sauer-Danfoss-Daikin LTD.
Shin-Osaka TERASAKI 3rd Bldg. 6F
1-5-28 Nishimiyahara, Yodogawa-ku
Osaka 532-0004, Japan
Phone: +81 6 6395 6066
Fax: +81 6 6395 8585