

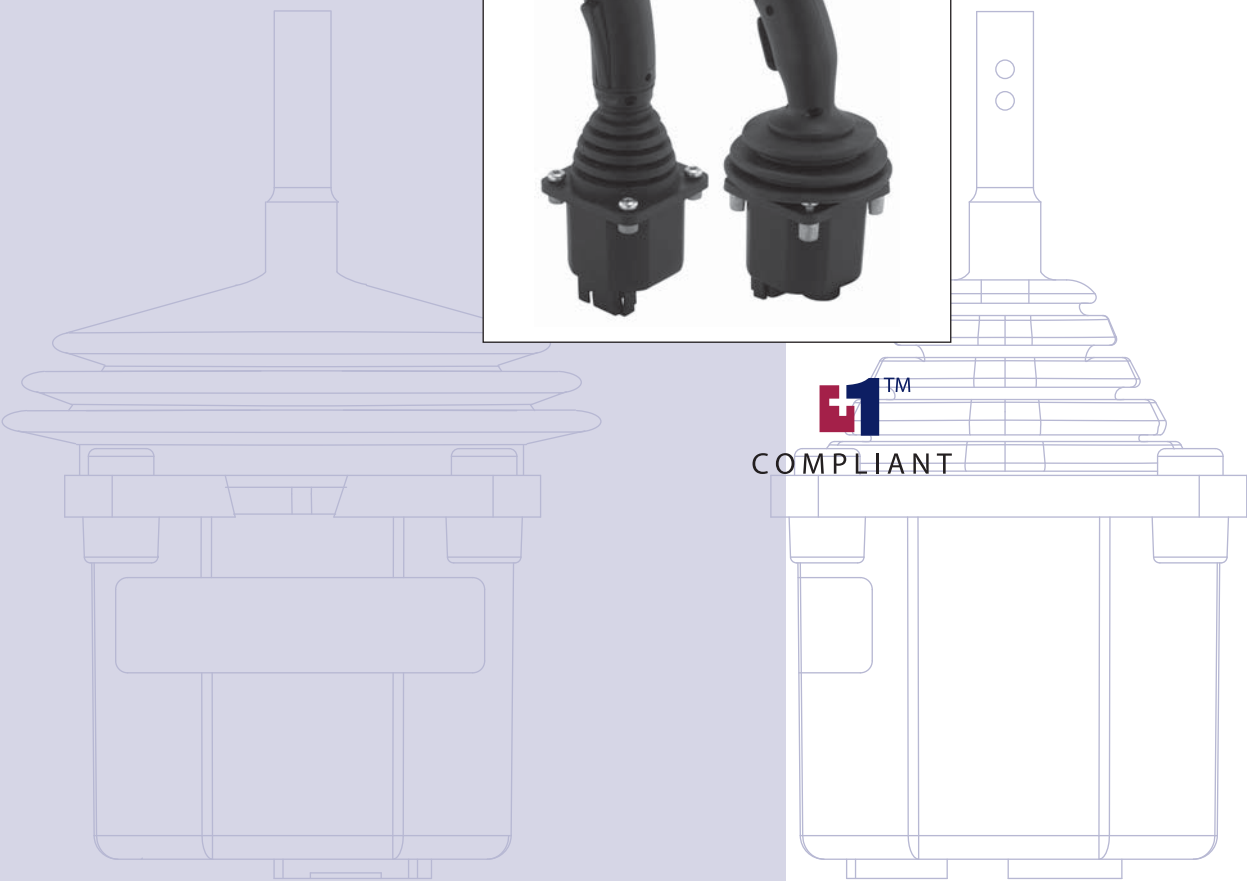

JS6000
Joystick Base

Technical
Information



COMPLIANT

Version

Revisions

Date	Page	Changed	Rev.
26 Feb, 2010	9, 27, 38	Axis base image, A Grip Front Plate Diagram illustration, Environmental Characteristics	JA
16 Sep, 2009	Various	Content update	IA
04 Jan, 2008	26	A grip front plate diagram updated	HA
14 Nov, 2007	3, 6, 7, 13, 17	Grip options model code details; mechanical options: friction hold torque	GA
28 Jun, 2007	15, 32, 36	Corrected temperature and length conversion	FA
27 Jun, 2007	Various	Text changes and addition of CAN+	EA
24 Apr, 2007	Various	Text changes	D
22 Feb, 2006	Various	Text changes	C
28 Nov, 2005	Various	Feature updates	B
26 May, 2005	33	Hall sensor pinouts	A
17 Dec, 2004		Initial release	

© 2010 Sauer-Danfoss. All rights reserved.

Sauer-Danfoss accepts no responsibility for possible errors in catalogs, brochures and other printed material. Sauer-Danfoss reserves the right to alter its products without prior notice. This also applies to products already ordered provided that such alterations can be made without affecting agreed specifications. All trademarks in this material are properties of their respective owners. Sauer-Danfoss, the Sauer-Danfoss logotype, the Sauer-Danfoss S-icon, PLUS+1™, what really matters is inside® and Know-How in Motion™ are trademarks of the Sauer-Danfoss Group.

Front cover illustrations: 2xxx, P005249

General Information	Product Overview	5
	Features and Options.....	5
Product Configuration	Product Configuration Model Code	6
	Base Model Code.....	7
	Grip Model Code.....	8
Model Code Details	Code B: Single or Dual Axis Options	9
	Code C: Shaft Sensor/Output Options.....	10
	Potentiometer Sensor	10
	Dual Potentiometer Outputs Per Axis	11
	Hall Effect Sensor	12
	Controller Area Network (CAN) Output	12
	Pulse Width Modulated (PWM) Output	12
	Code D: Centering Return Spring Options.....	13
	Code E: Hardware Configuration	13
	Code F: Mechanical Options.....	14
	Code G: Microswitch Option	16
	Code H: Electrical Interface Options.....	17
	Analog.....	17
	CAN 2.0B, J1939 Protocol.....	17
	CANopen 2.0B, J1939 Protocol	17
	PWM	17
	Code I, J, K,L Grip Options	18
JS6000 CAN Messages	CAN Option	19
	CAN+ Option.....	19
	CAN+ External Inputs	19
	Analog Inputs (AIN).....	19
	Digital Inputs (DIN).....	19
CAN Message Protocol	SAE J1939 CAN Message Specification.....	21
	SAE J1939 Basic Joystick Message	21
	Data Field	21
	Basic Joystick Message Data Field Descriptions	22
	SAE J1939 Extended Joystick Message	25
	SAE J1939 Error (DM1) Messages	26
	SAE CANopen Protocol Information.....	26
	A Grip Button and Rocker CAN Naming Conventions	27
	Top and Operator Present Switch Naming Conventions.....	27
	Proportional Rocker Naming Conventions.....	27
MG Grip Button CAN Naming Conventions.....	28	

Product Installation

Dimensions and Mounting	29
Recommended Wiring Practice.....	30
Joystick Safety	31
JS6000 Connector Pin Assignments General Information	32
Pin Assignments	32
CAN Output Connector Pin Assignments	32
CAN Output Mating Connector Deutsch® DTM06-6S	32
CAN+ and PWM Output Connector Pin Assignments.....	33
CAN+ and PWM Output Mating Connector Deutsch® DT16-18SB	33
Potentiometer Sensor with Analog Output Connector Pin Assignments.....	34
Analog Output Mating Connector	34
Hall Effect Sensor with Analog Output Pin Assignments	35

Specifications

Mechanical Characteristics	36
Electrical Characteristics.....	36
Microswitch Characteristics.....	38
Sensor Power Supply Ratings	38
Environmental Characteristics.....	38

Product Overview

The JS6000 Joystick Base has been specially developed to meet the harsh operating requirements of today's mobile machines. The JS6000 features metal construction with a large diameter stainless steel operating shaft, an innovative ball and socket gimbal design manufactured from pressure die cast zinc alloys, a custom high strength material for the center return cone, and optional contactless Hall effect sensing technology.

The CAN+ version of the JS6000 base allows the value and state of up to eleven digital or seven digital and four analog inputs from external-to-the-joystick sources to be broadcast along with joystick Controller Area network (CAN) messages.

The Pulse Width Modulation (PWM) version of the JS6000 base can be used to directly drive a valve, such as the H1 hydrostatic transmission, without an intermediate microcontroller. This version allows joystick operating parameters (e.g. ramp rates, button function assignments, output characteristics) to be configured using the PLUS+1 GUIDE Service Tool interface. Refer to *JS6000 PWM User Manual, 11060942* for instructions and information required to configure JS6000 PWM joystick options.

The flexible design of the JS6000 offers many options, making it the right choice for applications that require more than a simple dual axis joystick with spring return to center. This technical manual describes the many different features that can be selected to configure the right product for a specific application.

JS6000 Joystick Base

F101 445

Features and Options

- Hall effect or potentiometer sensing (model dependent)
- One or two sensors per axis for redundancy
- Single or dual axis
- Mechanical direction switches
- 2 centering spring forces
- 3 available friction-hold options
- Output options:
 - Analog
 - CAN 2.0B, J1939 protocol
 - CANopen protocol
 - High current PWM
- Multiple grip options:
 - HKN - plain knob
 - MG - with operator trigger and hand rest
 - A - configurable ergonomic
 - Custom designed grips
- External-to-joystick analog and digital information included in JS6000 CAN+messages

**Product Configuration
Model Code**

Use the JS6000 product configuration model code to specify particular features when ordering a JS6000 joystick. The model code begins with the product family name: JS6000. Fill in the remaining fields to configure the product with the desired features.

The model code includes both joystick base and joystick grip information. This technical manual provides information required to configure the base portion of the joystick. The Sauer-Danfoss manual *JS1000, JS6000 Joystick Grips Technical Information 520L0872* provides information required to configure JS6000 joystick grips.

Product Configuration Model Code Example

J	S	6	0	0	0	X	Y	H	M	M	H	S	N	L	N	J	3	3	1	A	0	H	0	R	V	N	N	N	N	N	N	N	N
---	---	---	---	---	---	---	---	---	---	---	---	---	---	---	---	---	---	---	---	---	---	---	---	---	---	---	---	---	---	---	---	---	---

Base Model Code

JS6000 Product Configuration Model Code Example

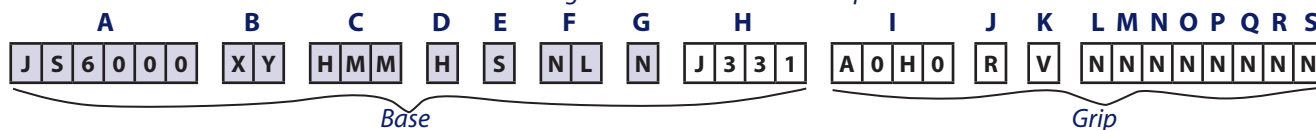

A Product Series

Code	Description
JS6000	Series JS6000 Joystick

B Operational Axis Options

Code	Description
XY	Bi-directional: X and Y axis
NY	Uni-directional: Y axis only (required for friction-holding)

C Shaft Position Sensing and Output Options

Code	Description
PRR	Potentiometer: single output per axis; $V_o = 10$ to 90% of V_s ; $\pm 1.5^\circ$ neutral threshold
PQQ	Potentiometer: single output per axis; $V_o = 25$ to 75% of V_s ; $\pm 1.5^\circ$ neutral threshold
PSS	Potentiometer: single output per axis; $V_o = 10$ to 90% of V_s ; $\pm 5^\circ$ neutral threshold
PTT	Potentiometer: single output per axis; $V_o = 25$ to 75% of V_s ; $\pm 5^\circ$ neutral threshold
PUU	Potentiometer: dual output per axis; $V_o = 10$ to 90% of V_s ; $\pm 1.5^\circ$ neutral threshold
HMM	Hall effect: dual sensors per axis; $V_s = 5 V_{DC}$; $V_o = 0.5$ to $4.5 V_{DC}$
CAN*	Hall effect: dual sensors per axis; $V_s = 9$ to $36 V_{DC}$; CAN 2.0B J1939 communication, 6 pin connector
CANopen*	Hall effect: dual sensors per axis; $V_s = 9$ to $36 V_{DC}$; CANopen 2.0B J1939 communication, 6 pin connector
CPL	Hall effect: dual sensors per axis; $V_s = 9$ to $36 V_{DC}$; CAN 2.0B communication, 18 pin connector
PWM	Hall effect: dual sensors per axis; $V_s = 9$ to $36 V_{DC}$; high current PWM and digital outputs

* See H1 Electrical Interface Options, page 17.

D Centering Spring Options

Code	Description
H	Heavy force
M	Medium force
F	Friction-hold (position maintained, center detent)

E Gate Pattern Options

Code	Description
S	Square, full output at 45 degree

F Mechanical Options

Code	Description
NL	No mechanical option; spring return to center only
FB	Friction-held in Y axis; no X axis; center detent; 1.25 N·m [0.92 lb·ft] friction-hold force; 2.5 N·m [1.66 lb·ft] breakout force
FC	Friction-held in Y axis; no X axis; center detent; 1.25 N·m [0.92 lb·ft] friction-hold force; 3.25 N·m [2.40 lb·ft] breakout force
HC	Friction-held in Y axis; no X axis; center detent; 2.25 N·m [1.66 lb·ft] friction-hold force; 4.0 N·m [2.95 lb·ft] breakout force

G Direction (Microswitch) Options

Code	Description
N	No switches
Y	Microswitches installed

Grip Model Code

JS6000 Product Configuration Model Code Example

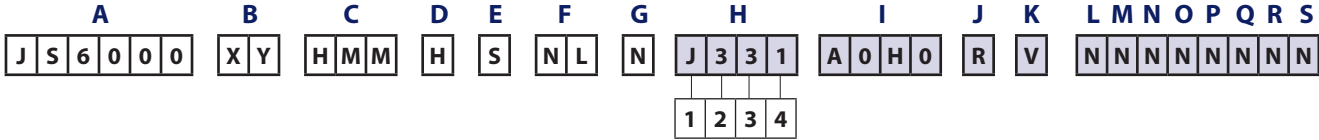

H1 *Electrical Interface Options*

Code	Description
S	Analog (DC voltage output)
J	CAN, SAE J1939 protocol
W	PWM output
P	CANopen protocol (default: 125 Kbit band rate)

H2, 3 *CAN Source Address**

Code	Description
NN	None—use with analog outputs when H1 = S
33	Source address = 0x 33 (use this source address with PWM outputs.)
34	Source address = 0x 34
35	Source address = 0x 35
36	Source address = 0x 36

H4 *Joystick Output Type*

Code	Description
N	None—use with analog and PWM outputs
1	CAN full scale output = 1000 counts

I, J, K, L, M, N, O, P, Q, R, S *Grip Options*

The Sauer-Danfoss manual *JS1000, JS6000 Joystick Grips Technical Information 520L0872* provides information required to configure the JS6000 joystick grip.

* Consult the factory if additional source addresses are required.

**Code C: Shaft Sensor/
 Output Options**

JS6000 Product Configuration Model Code C



Code C designates the shaft sensing technology; potentiometer or Hall effect; and the electrical output characteristics of the joystick base.

C Shaft Position Sensing and Output Options

Code	Description
PRR	Potentiometer: single output per axis; $V_o = 10$ to 90% of V_s ; $\pm 1.5^\circ$ neutral threshold
PQQ	Potentiometer: single output per axis; $V_o = 25$ to 75% of V_s ; $\pm 1.5^\circ$ neutral threshold
PSS	Potentiometer: single output per axis; $V_o = 10$ to 90% of V_s ; $\pm 5^\circ$ neutral threshold
PTT	Potentiometer: single output per axis; $V_o = 25$ to 75% of V_s ; $\pm 5^\circ$ neutral threshold
PUU	Potentiometer: dual output per axis; $V_o = 10$ to 90% of V_s ; $\pm 1.5^\circ$ neutral threshold
HMM	Hall effect: dual sensors per axis; $V_s = 5 V_{DC}$; $V_o = 0.5$ to $4.5 V_{DC}$
CAN*	Hall effect: dual sensors per axis; $V_s = 9$ to $36 V_{DC}$; CAN 2.0B J1939 communication, 6 pin connector
CANopen*	Hall effect: dual sensors per axis; $V_s = 9$ to $36 V_{DC}$; CANopen 2.0B J1939 communication, 6 pin connector
CPL	Hall effect: dual sensors per axis; $V_s = 9$ to $36 V_{DC}$; CAN 2.0B communication, 18 pin connector
PWM	Hall effect: dual sensors per axis; $V_s = 9$ to $36 V_{DC}$; high current PWM and digital outputs

* See H1 Electrical Interface Options, page 17.

Potentiometer Sensor

The potentiometer sensor electrical connections are made via a 16 pin AMP® 040 series MULTILOCK connector mounted on the base of the unit.

Potentiometer outputs are ratiometric. The output value is dependent on the supply voltage. When the joystick handle returns to center, the output will be between 48% and 52% of supply voltage (V_s).

Potentiometer Sensor Specifications

Minimum load impedance	1 M Ω recommended
Maximum wiper current	5 mA
Supply voltage	< 36 Vdc
Center tap/switch alignment	Within 0.5°
Potentiometer electrical angle	$\pm 18^\circ$
Center tap angle	$\pm 2.5^\circ$
Insulation resistance at 50 Vdc	>50 M Ω

Center Tap

A center tap is standard on all potentiometer tracks, where 50% of the supply voltage can be supplied to force the sensor voltage to this known reference. When the center tap is not connected there will be a center dead band (where the voltage output does not change on initial deflection) and the output voltage will be between 48 and 52% of the supply voltage.

Directional Potentiometer Switches

Potentiometer tracks have directional and normally closed (center on) position switches that operate at the angles shown in the table below. Switch outputs are independent of the proportional potentiometer elements on each axis and can be terminated by the customer to provide directional or center on/off data to the control system.

Directional Potentiometer Switches Specifications

Maximum load current	200 mA resistive
Maximum supply voltage	< 36 Vdc

**Code C: Shaft Sensor/
 Output Options
 (continued)**

Directional Potentiometer Switch Circuit Diagram

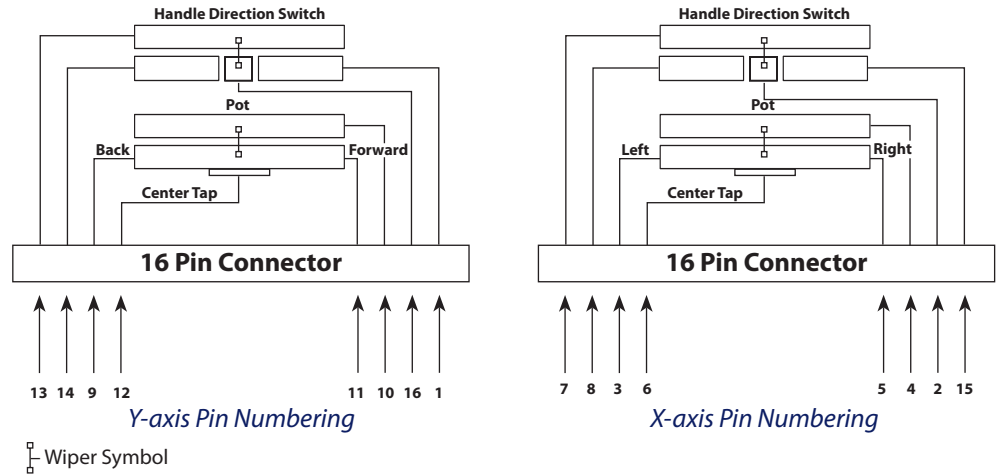

Potentiometer Track Outputs

Minimum output Voltage (% Vs)	Maximum output Voltage (% Vs)	Switch track angle	Resistance kΩ	Order code
10 ± 2	90 ± 2	±1.5°	1.6 to 2.4	R
25 ± 2	75 ± 2	±1.5°	2.2 to 3.6	Q
10 ± 2	90 ± 2	±5°	1.6 to 2.4	S
25 ± 2	75 ± 2	±5°	2.2 to 3.6	T

⚠ Warning

Potential uncommanded machine movement. When a JS6000 joystick with the 25% to 75% potentiometer output option (designated Q or T) is used to directly drive a PVG valve, if the power or ground side of the joystick is lost, there is a risk of the valve going full on in one direction or the other. To avoid the possibility of unintended machine motion, the PVG valve must have Active Fault Monitoring.

Dual Potentiometer Outputs Per Axis

Dual potentiometer outputs are available that feature independent power inputs and sensor outputs. The secondary potentiometer output connections are via an 8 pin AMP® connector. Secondary potentiometer outputs do not provide secondary directional and center switches.

Hall sensing and dual potentiometer outputs are not available together.

Dual Potentiometer Track Selection

Minimum output Voltage (% Vs)	Maximum output Voltage (% Vs)	Switch track angle	Resistance kΩ	Order code
10 ± 2	90 ± 2	±1.5°	1.6 to 2.4	U

**Code C: Shaft Sensor/
 Output Options
 (continued)**

Hall Effect Sensor

The Hall effect sensor option includes dual sensors per axis. The sensors can be supplied from two separate regulated 5 V supplies for a higher degree of redundancy, or can be supplied from a single regulated 5 V supply.

Hall effect sensing electrical connections are made via a 12 pin AMP® 040 series MULTILOCK connector on the base of the unit.

JS6000 Hall effect sensors are affected by temperature. Output values change temporarily by 2.6% and permanently by 0.6% when subjected to a -40°C (-40°F) to 80°C (176°F) operating temperature range cycle.

Hall Effect Sensor Specifications

Supply voltage (Vs)	5 Vdc regulated
Minimum output voltage	10% ± 4% Vs
Center voltage	50% ± 2% Vs
Maximum output voltage	90% ± 4% Vs

Controller Area Network (CAN) Output

Three versions of JS6000 CAN joysticks are available:

CAN (Configuration Model Code CAN)

CAN 2.0bB J1939 protocol and CANopen 2.0B J1939 protocol (reference product configuration model code, under H1 designator, see page 17).

CAN+ (Configuration Model Code CPL)

Broadcasts joystick shaft position, grip switch states, grip proportional rocker position and the state and value of up to 11 digital (DIN) or 7 digital (DIN) and 4 analog (AIN) inputs from sources external to the joystick. The CAN+ option joystick base has an 18 pin Deutsch connector.

Pulse Width Modulated (PWM) Output

One version of the JS6000 PWM joystick is available.

PWM (Configuration Model Code PWM)

Has two bi-directional PWM channels and six Digital Outputs. The PWM option joystick base has an 18 pin Deutsch connector.

**Code D: Centering
 Return Spring Options**

JS6000 Product Configuration Model Code D



Code D designates centering spring force options.

The center spring returns the joystick to its center position when released by the operator and provides the physical resistance to movement when the joystick is operated. Two levels of spring force are available: *heavy* and *medium*. Spring force is selected by choosing a *letter* from the order character column of the following table.

▲ Warning

Potential uncommanded machine movement. The spring choice affects the joystick’s ability to resist system vibrations. Each of the following springs give a different product harmonic range. This, in combination with critical mass differences as a result of grip choice, results in each system (joystick and machine) having different vibration characteristics. With this in mind, please consider the vibration range of the system and determine whether any resonance exists in the joystick. Resonance causes dither and could cause the joystick to leave neutral.

Centering Spring Selection

Spring option	Breakout force on axis	Force at full deflection	Order code
Heavy duty spring	12 to 19 N [2.7 to 4.3 lbf]	31 to 47 N [6.7 to 10.6 lbf]	H
Medium duty spring	6 to 8.5 N [1.3 to 1.9 lbf]	15 to 23 N [3.4 to 5.2 lbf]	M

The above forces are measured 55 mm (2.17 in) from the joystick mounting surface and are perpendicular to the shaft.

**Code E: Hardware
 Configuration**

JS6000 Product Configuration Model Code E



Code E designates hardware configuration.

JS6000 joysticks have a square gate pattern as the standard configuration. This is designated as **S** in the configuration code and includes a standard label.

Gate Selection

Gate option	Characteristics	Order code
Square 	± 20° mechanical travel (on axis)	S

The square gate offers full X and Y outputs when the joystick is moved to the corner positions.

Code F: Mechanical Options

JS6000 Product Configuration Model Code F



Code F designates joystick mechanical options.

JS6000 joysticks are available with a friction-hold option. With this option, the joystick handle position will remain in a position set by the operator and will not automatically return to center. This option is only available in a single (Y) axis configuration. Four levels of friction/breakout from center force are available.

Friction-hold Selection

Friction-hold torque	Center detent breakout torque	Order code
No mechanical options		NL
1.25 N•m (0.92 lb•ft)	2.50 N•m (1.84 lb•ft)	FB
1.25 N•m (0.92 lb•ft)	3.25 N•m (2.40 lb•ft)	FC
2.25 N•m (1.66 lb•ft)	4.00 N•m (2.95 lb•ft)	HC

JS6000 FB Option

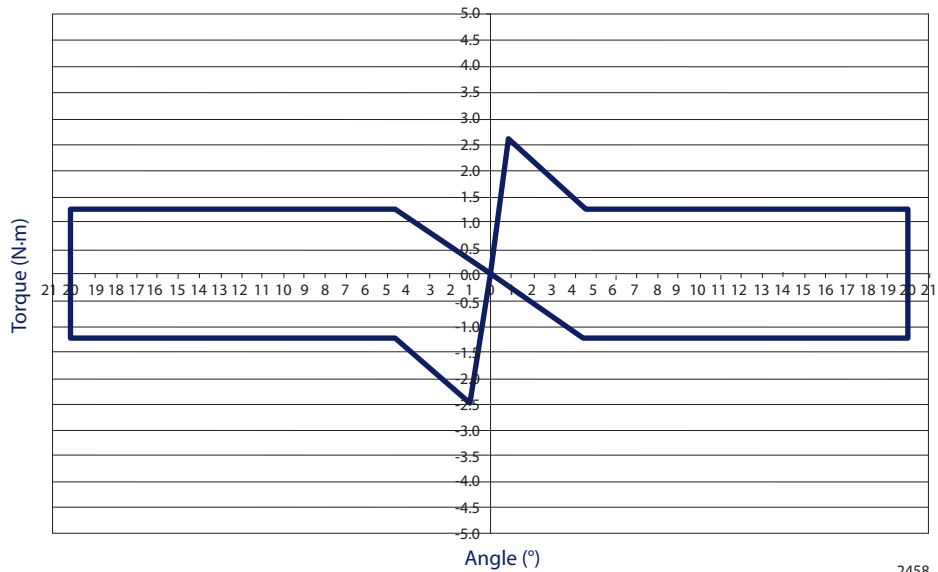

**Code F: Mechanical
 Options (continued)**

JS6000 FC Option

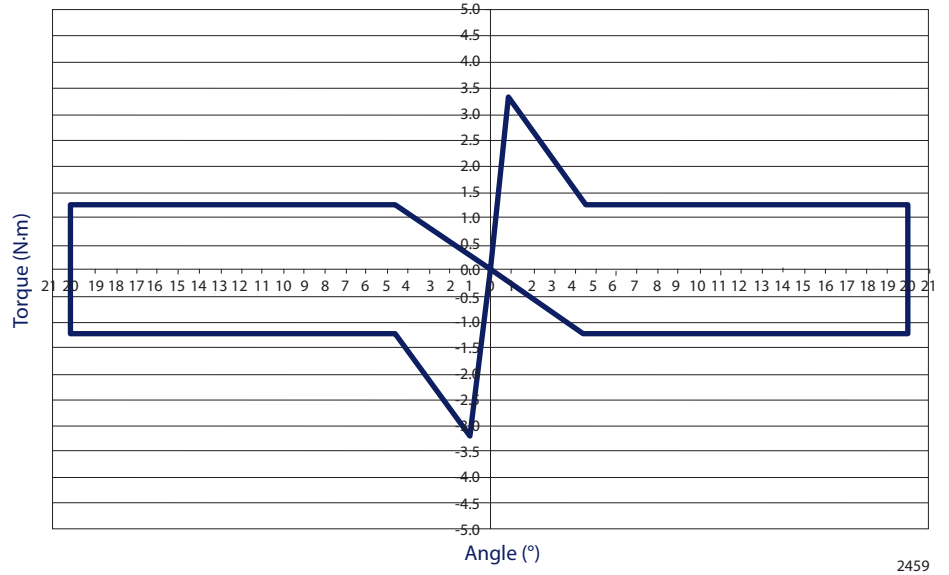

2459

JS6000 HC Option

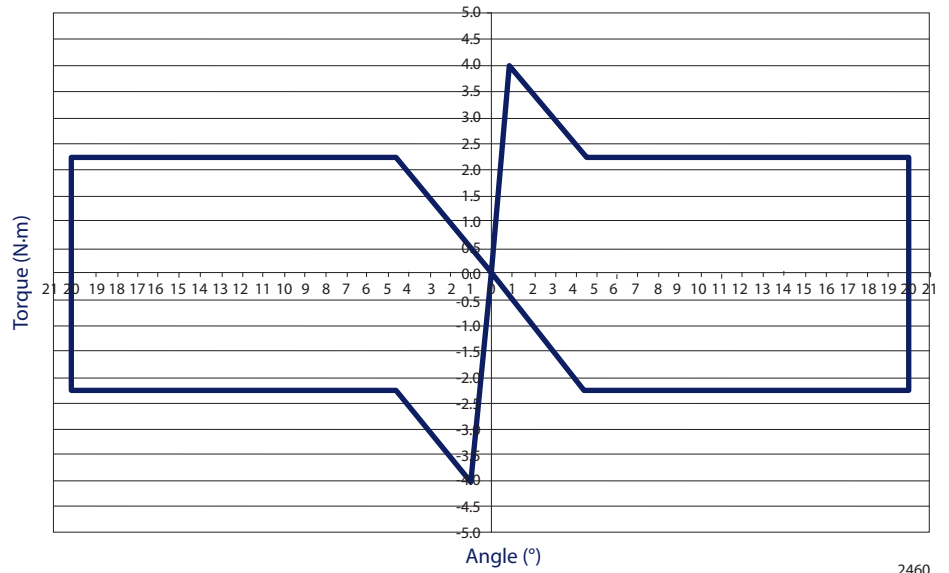

2460

Code G: Microswitch Option

JS6000 Product Configuration Model Code G



Code G designates joystick microswitch options.

Optional microswitch outputs can replace the low current directional potentiometer switches on the potentiometer tracks. Microswitch outputs are on the 16 pin connector (potentiometer option). There are two switches per axis and the microswitches are configured as normally open, with the handle centered. The microswitch joystick shaft direction indication feature is not available with the dual potentiometer sensing option.

Optional microswitches are also available with the Hall effect sensing option. Microswitch outputs, in this case, are on the 8 pin connector.

Optional microswitches are only available on analog output joysticks with the spring-return-to-center mechanical operation.

Optional microswitches are not available on BMM, CAN, CPL, or PWM output joysticks.

The Honeywell® microswitch electrical details follow. These details are taken directly from the switch manufacturer’s specification. Further information is available from www.honeywell.com.

- Microswitch operates at a mechanical deflection of 2 to 5 degrees in any direction
- Contact ratings are 3 A at 125 Vac, 2 A at 30 Vdc
- Life rating is 100,000 cycles minimum at 1 A 12 Vdc
- Temperature range is -25°C to 85°C [-13°F to 185°F] (when fitted, the joystick temperature is limited to this range)

With the microswitch option, choose the *letter* from the order character column of the following table. The choice is either **Y** for microswitch **N** for none.

Microswitch Option

Microswitch option	Mechanical function description	Order code
Without microswitch	No switches	N
Microswitch	Microswitches installed	Y

Code H: Electrical Interface Options

JS6000 Product Configuration Model Code H

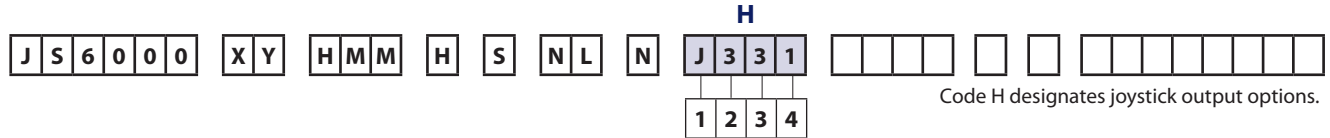

JS6000 joystick base signal outputs are available in analog voltage, PWM, or Controller Area Network (CAN) versions.

Analog

The analog output option gives a direct voltage output from the joystick’s shaft sensors, position switches and grip functions. No signal conditioning is performed. The PWM output option provides a conditioned output from the joystick’s shaft sensors, position switches, and grip functions. Output characteristics are configured using the PLUS+1 GUIDE Service Tool.

CAN 2.0B, J1939 Protocol

The CAN J1939 output option provides conditioned joystick output information in 2.0B, J1039 message protocol.

CANopen 2.0B, J1939 Protocol

The CANopen output option provides conditioned joystick output information in 2.0B, CANopen message protocol.

PWM

The PWM output option provides high voltage outputs for directly driving valves. The CAN port is active on the PWM version, but it is not designed to be used on a CAN bus in a system with other devices. The CAN bus is only to be used for configuration and data logging while connected to a PC running the PLUS+1 GUIDE Service Tool.

H1 Electrical Interface Options

Code	Description
S	Analog voltage
J	CAN 2.0B, J1939 protocol
P	CAN 2.0B, CANopen protocol
W	PWM

H4 CAN Proportional Output

Code	Description
N	None (if Analog or PWM)
1	CAN full scale output = 1000 counts

H2, 3 Joystick Location/CAN Source Address*

Code	Description
NN	None—use when H1 = S
33	Source address = 0x 33
34	Source address = 0x 34
35	Source address = 0x 35
36	Source address = 0x 36

* Source addresses are factory set. Additional addresses are available upon request.

Code I, J, K, L Grip Options JS6000 Product Configuration Model Code I

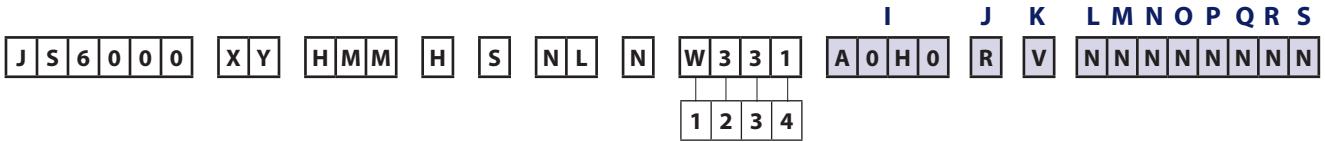

The Sauer-Danfoss manual *JS1000, JS6000 Joystick Grips Technical Information 520L0872* provides instructions and information required to specify JS6000 joystick grip options.

CAN Option

Joysticks CAN J1939 protocol option, designated as model code CAN, broadcasts two J1939 messages to communicate device information: Basic Joystick Message 1 (BJM1) and Extended Joystick Message 1 (EJM1). The two CAN options available are:

- CAN 2.0B, J1939 Protocol Option
- CAN 2.0B, CANopen Protocol Option

CAN+ Option

Joysticks with the CAN+ option, designated as model code CPL, allow eleven external inputs that are not associated with the joystick shaft position or grip functions to be read by the joystick's microcontroller and broadcast by the joystick's CAN transceiver.

CAN+ joysticks broadcast four CAN messages. Basic Joystick Message 1 and Extended Joystick Message 1 have the same data content as the CAN option, above. External digital input (DIN) and analog input (AIN) input information is contained in Basic Joystick Message 3 and Extended Joystick Message 3. The data field format for Basic Joystick Message 3 and Extended Joystick Message 3 is the same as that for Basic Joystick Message 1 and Extended Joystick Message 1.

CAN+ External Inputs Analog Inputs (AIN)

- All external analog inputs must be powered by the JS6000 joystick 5 Vdc regulated power supply (connector pin 8).
- No calibration, error checking or software filtering is performed on analog data received from external inputs.
- External analog data is scaled in raw form from 0 to 1000 counts.
- Data associated with CAN+ pins 9, 10, 11 and 12 is broadcast in both Basic Joystick Message 3 and Extended Joystick Message 3. For analog inputs use the appropriate data bytes in Basic Joystick Message 3 or Extended Joystick Message 3.

Digital Inputs (DIN)

- External inputs are pull-down and must be powered by a voltage source <32 Vdc. Low state is interpreted as <0.97 Vdc. High state is interpreted as >4.00 Vdc.
- Data associated with CAN+ pins 9, 10, 11, 12 is broadcast in both BJM3 and EJM3. For digital inputs use the appropriate data bytes in BJM3.

See Sauer-Danfoss publication *JS6000 PWM Service Tool User Manual*, **11060942** for technical details on the JS6000 PWM Joystick Base and complete details regarding the use of the PLUS+1 GUIDE Service Tool interface for troubleshooting and configuring the device.

Obtain free Service Tool software license and download the P1D file at:
<http://www.sauer-danfoss.com/Products/MobileElectronics/PLUS1Guide/PLUS1GuideDownloads/PLUS1GUIDEServiceToolSoftwareLicense/index.htm>

**CAN+ External Inputs
 (continued)**

External Input Pin Assignment/J1939 Basic Joystick Message 3 Designation

CAN+ connector pin number	CAN+ function	Corresponding J1939 BJM3 data field designation
7	5 Vdc sensor power (0 = 0 Vdc, 1000 = 5.25 Vdc)	X-Axis Position
9	External input pin 9 AIN. Use if pin 9 data is required in analog form (0 = 0 Vdc, 1000 = 5.00 Vdc)	Y-Axis Position
9	External input pin 9 DIN status. Use if pin 9 data is required in digital form	Button 1
10	External input pin 10 DIN status. Use if pin 10 data is required in digital form	Button 2
11	External input pin 11 DIN status. Use if pin 11 data is required in digital form	Button 3
12	External input pin 12 DIN status. Use if pin 12 data is required in digital form	Button 4
13	External input pin 13 status	Button 5
14	External input pin 14 status	Button 6
15	External input pin 15 status	Button 7
16	External input pin 16 status	Button 8
17	External input pin 17 status	Button 9
18	External input pin 18 status	Button 10
6	External input pin 6 status (see <i>Warning</i> statement below)	Button 11

⚠ Warning

Potential uncommanded machine movement. JS6000 CAN+ Joysticks fitted with an operator present switch have an internal connection between the operator present switch and pin 6. The operator present switch status is broadcast in BJM1 and BJM3. Unintended machine motion may result if an external DIN is applied to pin 6 with a joystick that has a grip with operator present switch.

External Input Pin Assignment/J1939 Extended Joystick Message 3 Designation

CAN+ connector pin number	CAN+ function	Corresponding J1939 EJM3 data field designation
10	External input pin 10 AIN. Use if pin 10 data is required in analog form (0 = 0 Vdc, 1000 = 5.00 Vdc)	Grip X-Axis
11	External input pin 11 AIN. Use if pin 11 data is required in analog form (0 = 0 Vdc, 1000 = 5.00 Vdc)	Grip Y-Axis
12	External input pin 12 AIN. Use if pin 12 data is required in analog form (0 = 0 Vdc, 1000 = 5.00 Vdc)	Grip Theta-Axis

SAE J1939 CAN Message Specification

SAE J1939 Basic Joystick Message

The JS6000 joystick uses the SAE J1939 basic joystick message to transfer information about the measured status of the X and Y axes of a joystick, the state of switches on the joystick grip, and the state of external-to-the-joystick digital inputs.

Basic Joystick Message Structure

Basic message number	Priority	Base PGN		PDU format		PDU specific		Source address		Data field
		Dec	hex	Dec	hex	Dec	hex	Dec	hex	
1	3	64982	FDD6	253	FD	214	D6	*	*	8 bytes
3	3		FDDA		FD		DA	*	*	8 bytes

* Depends on position specified in master model code. See *H2, 3 Joystick Location/CAN Source Address*, page 17.

Message transmission rate: 20 ms
 CAN bus baud rate: 250kbps

The resulting SAE J1939 basic joystick message PGN on the CAN bus is:
 0xCFDD6_{*} or 0xCFDDA_{*}

* = joystick source address (hex)

Data Field

The data field contains the joystick's output information. SAE J1939 data fields contain 8 bytes of data.

Information in the Data Field

Byte#	0								1								2 and so on							
Bit#	1	2	3	4	5	6	7	8	1	2	3	4	5	6	7	8	1	2	3	4	5	6	7	8

SAE J1939 CAN Message
 Specification
 (continued)

Basic Joystick Message Data Field Descriptions

Basic Joystick Message Parameters and Data Field Locations

Start position (byte/bit)	Length (bits)	Parameter name
0/1	2	Joystick X-axis neutral position status
0/3	2	Joystick X-axis lever left negative position status
0/5	2	Joystick X-axis lever right positive position status
0/7 through 1/1-8	10	Joystick X-axis position (Byte 0 Bit 7 is LSB. Byte 1 Bit 8 is MSB)
2/1	2	Joystick Y-axis neutral position status
2/3	2	Joystick Y-axis lever back negative position
2/5	2	Joystick Y-axis lever forward positive position
2/7 through 3/1-8	10	Joystick Y-axis position (Byte 2 Bit 7 is LSB. Byte 3 Bit 8 is MSB)
4/5	2	Joystick Y-axis detent position status
4/7	2	Joystick X-axis detent position status
5/1	2	Grip button 4 pressed status
5/3	2	Grip button 3 pressed status
5/5	2	Grip button 2 pressed status
5/7	2	Grip button 1 pressed status
6/1	2	Grip button 8 pressed status
6/3	2	Grip button 7 pressed status
6/5	2	Grip button 6 pressed status
6/7	2	Grip button 5 pressed status
7/1	2	Grip button 12 pressed status
7/3	2	Grip button 11 pressed status
7/5	2	Grip button 10 presses status
7/7	2	Grip button 9 pressed status

Button naming convention: Refer to the illustrated *A Grip Button and Rocker CAN Naming Conventions*, page 27, for button and proportional input definitions.

Data Field Examples

Byte	0								
Bit	8	7	6	5	4	3	2	1	
	The 2 LSB* of X-axis position			X-axis lever right positive status		X-axis lever left negative position status		X-axis neutral position status	

*Least Significant Bit

Byte	1							
Bit	8	7	6	5	4	3	2	1
	MSB* X-axis position							

*Most Significant Bit

Byte	2								
Bit	8	7	6	5	4	3	2	1	
	The 2 LSB* of Y-axis position status			X-axis lever forward positive status		Y-axis lever back negative position status		Y-axis neutral position status	

*Least Significant Bit

SAE J1939 CAN Message
 Specification
 (continued)

Basic Joystick Message Data Field Descriptions (continued)

Joystick X-axis Neutral Position Status

Reports when the current joystick position is in the neutral position for the X-axis of travel.

Information in the Data Field

Bit status	Remarks
00	Not in neutral position
01	In neutral position
10	Error indicator
11	Not available

Joystick X-axis Handle Left Negative Position Status

Reports when the current joystick position is on the negative travel side (back, left, counterclockwise, down) relative to the neutral position for the X-axis.

Information in the Data Field

Bit status	Remarks
00	Not on negative side of neutral
01	On negative side of neutral
10	Error indicator
11	Not available

Joystick X-axis Handle Right Positive Position Status

Reports when the current joystick position is on the positive travel side (forward, right, clockwise, up) relative to the neutral position for the X-axis.

Information in the Data Field

Bit status	Remarks
00	Not on positive side of neutral
01	On positive side of neutral
10	Error indicator
11	Not available

Joystick X-axis Position Status

The position of the joystick in the relative motion of travel from the neutral position. The position value of 0 is always neutral. The output range of the joystick handle at the end of travel is factory set according to the option specified in the *electrical interface options* section of the master model code.

The master model code specifies that the full-scale output at the end of each linear zone will be 1000 counts.

⚠ Warning

Potential uncommanded machine movement. Per the SAE J1939-71 standard, if the JS6000 joystick internal diagnostics detect a shaft position measurement error, the joystick output will be set to a value of 1022 counts regardless of shaft position. Application software should be written to recognize this error condition to avoid the possibility of unintended machine motion.

Per the SAE J1939-71 standard, if a specific joystick axis is not available, the basic joystick message for the unavailable axis will indicate an output value of 1023 counts. Application software should be written to recognize this condition to avoid the possibility of unintended machine motion.

SAE J1939 CAN Message
 Specification
 (continued)

Basic Joystick Message Data Field Descriptions (continued)

Joystick Y-axis Neutral Position Status

Reports when the current joystick position is in the neutral position for the Y-axis of travel.

Information in the Data Field

Bit status	Remarks
00	Not in neutral position
01	In neutral position
10	Error indicator
11	Not available

Joystick Y-axis Handle Back Negative Position Status

Reports when the current joystick position is on the negative travel side (back, left, counterclockwise, down) relative to the neutral position for the Y-axis.

Information in the Data Field

Bit status	Remarks
00	Not on negative side of neutral
01	On negative side of neutral
10	Error indicator
11	Not available

Joystick Y-axis Handle Forward Positive Position Status

Reports when the current joystick position is on the positive travel side (forward, right, clockwise, up) relative to the neutral position for the Y-axis.

Information in the Data Field

Bit status	Remarks
00	Not on positive side of neutral
01	On positive side of neutral
10	Error indicator
11	Not available

Joystick Y-axis Position Status

The position of the joystick in the relative motion of travel from the neutral position. The position value of 0 is always neutral. The output range of the joystick handle at the end of travel is factory set according to the option specified in the *electrical interface options* section of the master model code.

The master model code specifies that the full-scale output at the end of each linear zone will be 1000 counts.

⚠ Warning

Potential uncommanded machine movement. Per the SAE J1939-71 standard, if the JS6000 joystick internal diagnostics detect a shaft position measurement error, the joystick output will be set to a value of 1022 counts regardless of shaft position. Application software should be written to recognize this error condition to avoid the possibility of unintended machine motion.

Per the SAE J1939-71 standard, if a specific joystick axis is not available, the basic joystick message for the unavailable axis will indicate an output value of 1023 counts. Application software should be written to recognize this condition to avoid the possibility of unintended machine motion.

Joystick Button 1-8 Pressed Status

Bit status	Remarks
00	Button not pressed
01	Button pressed
10	Error indicator
11	Not available (no button installed)

SAE J1939 CAN Message Specification (continued)

SAE J1939 Extended Joystick Message

The JS6000 joystick uses the SAE J1939 extended joystick message to transfer information about the measured status of up to 3 additional proportional input functions on the joystick grip, and external-to-the-joystick analog inputs. The joystick base X and Y-axis information is available in the basic joystick message. The extended joystick message structure is as follows:

Extended Joystick Message Structure



Extended message number	Priority	Base PGN		PDU format		PDU specific		Source address		Data field
		Dec	hex	Dec	hex	Dec	hex	Dec	hex	
1	3	64983	FDD7	253	FD	215	D7	*	*	8 bytes
3			FDDB		FD		DB	*	*	8 bytes

* Depends on position specified in master model code. See *H2,3 Joystick Location/CAN Source Address*, page 17.

Message transmission rate: 20 ms

CAN bus baud rate: 250kbps

The resulting SAE J1939 basic joystick message PGN on the CAN bus is:

0xCFDD7  or 0xCFDDB 

* = joystick source address (hex)

Extended Joystick Message Parameters and Data Field Locations

Start position (byte/bit)	Length (bits)	Parameter name
0/1	2	Grip X-axis neutral position status
0/3	2	Grip X-axis lever left negative position status
0/5	2	Grip X-axis lever right positive position status
0/7 through 1/1-8	10	Grip X-axis position
2/1	2	Grip Y-axis neutral position status
2/3	2	Grip Y-axis lever back negative position
2/5	2	Grip Y-axis lever forward positive position
2/7 through 3/1-8	10	Grip Y-axis position
6/5	2	Grip Y-axis detent position status-not available
6/7	2	Grip X-axis detent position status-not available

Data field descriptions and output ranges for extended joystick messages are similar to those for base X and Y-axis basic joystick messages.

Grip Proportional Input Naming Convention

Proportional input location	Extended joystick message designation
Horizontal orientation, top	Y-axis
Horizontal orientation, bottom	X-axis
Vertical orientation, left side	X-axis
Vertical orientation, right side	Y-axis

Refer to the *A Grip Button and Rocker CAN Naming Conventions*, page 27, for proportional input naming conventions.

SAE J1939 CAN Message Specification (continued)

SAE J1939 Error (DM1) Messages

SAE J1939 DM1 error messages are supported by JS6000 software. See the tables below for SPN and FMI information.

Failure: Voltage Too High

Message	Axis	SPN	FMI
BJM1	X	2660	3
BJM1	Y	2661	3
BJM1	Grip X	2662	3
BJM1	Grip Y	2663	3
BJM1	Grip Theta	2664	3

Failure: Voltage Too Low

Message	Axis	SPN	FMI
BJM1	X	2660	4
BJM1	Y	2661	4
BJM1	Grip X	2662	4
BJM1	Grip Y	2663	4
BJM1	Grip Theta	2664	4

Failure: Input Not Calibrated

Message	Axis	SPN	FMI
BJM1	X	2660	13
BJM1	Y	2661	13
BJM1	Grip X	2662	13
BJM1	Grip Y	2663	13
BJM1	Grip Theta	2664	13

Failure: Redundant Input Failure

Message	Axis	SPN	FMI
BJM1	X	2660	14
BJM1	Y	2661	14
BJM1	Grip X	2662	14
BJM1	Grip Y	2663	14
BJM1	Grip Theta	2664	14

Sensor Power Fault (CAN+ Only)

Message	Power Fault	SPN	FMI
	Sensor power too high	3509	3
	Sensor power too low	3509	4

SAE CANopen Protocol Information

JS6000 joysticks do not support SAE J1939 dynamic addressing, since the joystick source addresses are hard-coded (static). However, JS6000 joysticks are compliant with SAE J1939 address claiming protocol (in the unlikely event another node on the SAE J1939 bus claims an identical source address to the JS6000, the JS6000 *may* cease communication on the bus, depending on the message priority of the other node).

When you want to use CANopen Joystick, go to <http://www.sauer-danfoss.com/Products/MobileElectronics/Joysticks/index.htm>, and click on CANopen EDS to open CANopen Object Dictionary

**A Grip Button and
 Rocker CAN Naming
 Conventions**

A Grip Front Plate Diagram

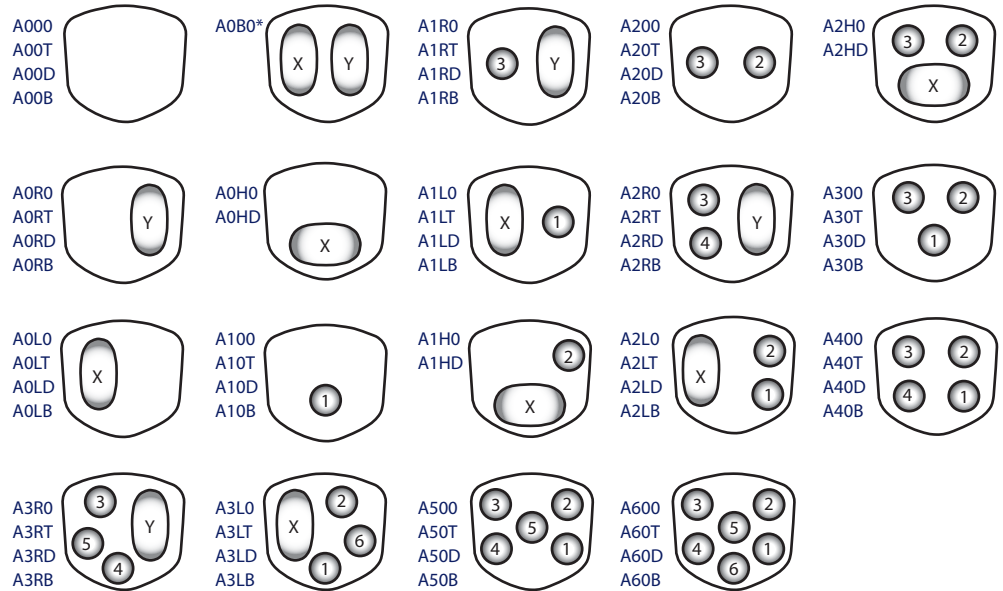

* For CAN and CAN+ output models, include grip configurations: A0BD, A0BB, A0BT.

2247B

Top and Operator Present Switch Naming Conventions

Top and operator present switch state information is broadcast on J1939 Basic Joystick Message 1 (BJM1)

Switch State Information

Top switch	BJM1 button 7
Operator present switch	BJM1 button 8

Proportional Rocker Naming Conventions

Grip rocker proportional output information is broadcast on J1939 Extended Joystick Message 1 (EJM1) using the X and Y axis data bits. See the above diagram for proportional rocker output X and Y naming conventions.

Each rocker switch also has two switch states—one for each end of travel. Rocker switch state information is broadcast on BJM1 concurrently with proportional output information. See the above diagram for rocker switch naming conventions.

**MG Grip Button CAN
Naming Conventions**

MG Grip Button CAN Naming Conventions

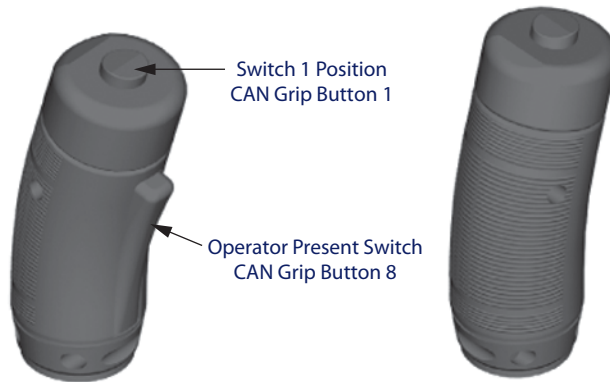
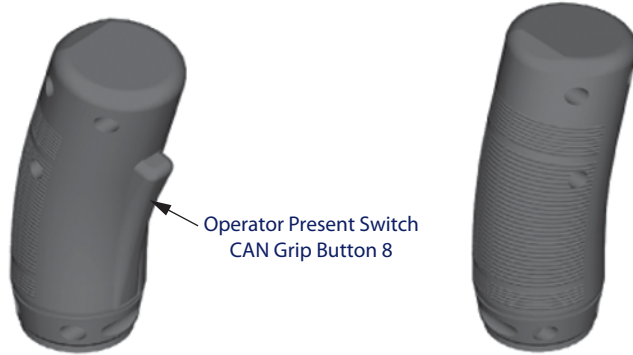

2461

Dimensions and Mounting

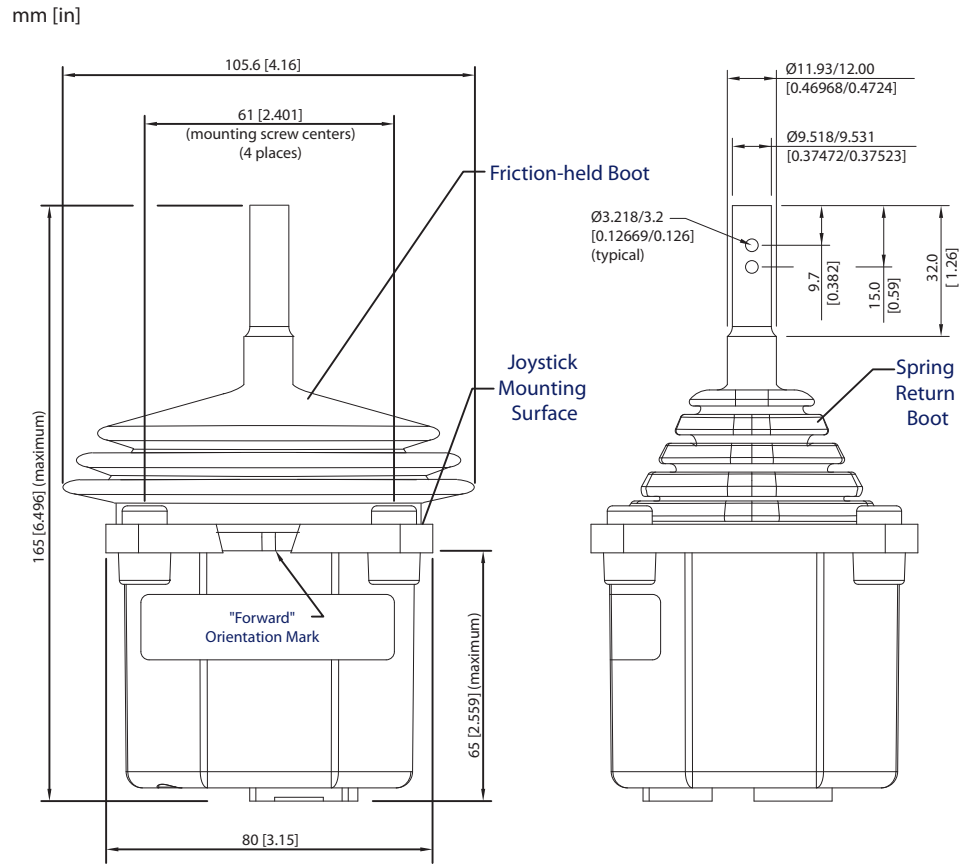

PO05250F

The JS6000 is designed to be installed from the panel below, through a 68 mm [2.677 in] diameter hole.

Drive mounting screws to a maximum torque of 5 N·m [44.25 lbf·in] when clamped against a 3.5 mm [0.138 in] thick panel. The joystick flange mounting hole depth is 12.6 mm [0.496 in]. For through-hole mounting, drive the screws at a torque of 3.5 N·m [30.98 lbf·in] directly through the blind cast holes to remove the cast covers.

Use fit and seal for fitting and sealing of the joystick into the mounting panel using the screws supplied. Note the following:

- The panel material type, thickness, strength and rigidity. Install in a panel with a minimum thickness of 3.5 to 6 mm [0.138 to 0.236 in]. This allows the mounting screws to correctly clamp the sealing boot.
- Apply the specified screw torque to ensure sufficient and even clamping force on the sealing boot.
- The mounting flange of the joystick should be connected to the vehicle chassis ground.

**Recommended Wiring
Practice**

- Protect all wires from mechanical abuse.
- Use 85°C [185°F] wire with abrasion resistant insulation.
- Use a wire gauge that is appropriate for the joystick electrical mating connector.
- Separate high current wires such as feeds to solenoids, lights, alternators, or fuel pumps from control wires. Recommended minimum separation is 300 mm [11.8 in].
- Run wires along the inside of or close to metal machine frame surfaces where possible. This simulates a shield which minimizes the effects of EMI/RFI radiation.
- Do not run wires near sharp metal corners. Run wires through grommets when rounding a corner.
- Provide strain relief for all wires.
- Avoid running wires near moving or vibrating components.
- Avoid long, unsupported wire spans.
- All sensors have dedicated wired power sources and ground returns: use them.
- Twist sensor lines about one turn every 100 mm [3.94 in].
- Use wire harness anchors that will allow wires to float with respect to the machine frame rather than rigid anchors.
- The mounting flange of the joystick base should be electrically connected to the machine reference ground plane.

Joystick Safety

For a system to operate safely it must be able to differentiate between commanded and uncommanded inputs. Take steps to detect and manage joystick and system failures that may cause an erroneous output.

For safety critical functions Sauer-Danfoss recommends you use an independent momentary action *system enable* switch. You can incorporate this switch into the joystick as an *operator presence* switch or can be a separate foot or hand operated momentary switch. Disable all joystick functions that the joystick controls when this switch is released.

Ensure the control system looks for the appropriate *system enable* switch input before the joystick is displaced from its neutral position. Enable functions only after receiving this input.

Applications using CAN joysticks should continuously monitor for the presence of the CAN messages on periodic basis. Messages are to be checked frequently enough for the system or operator to react if the CAN messages lose priority or are no longer received.

PWM joystick outputs will return to zero output if the joystick's embedded microcontroller detects a measurement error between the redundant shaft position sensors. Applications using the PWM joystick option should be designed to ensure a safe machine state exists in the event a joystick output goes to zero due to an error.

JS6000 Connector Pin Assignments General Information

JS6000 Joystick base pin assignments are a function of the following options:

- Type of shaft position sensor (potentiometer or Hall)
- Electrical output (analog or CAN)
- Grip type

Base pin and connector assignments are different for the potentiometer and Hall sensor options.

In all cases, grip pin assignments are dependent on the type of grip and the number of grip options that are selected.

For *CAN Output Connector Pin Assignments*, see below.

For *CAN+ and PWM Output Connector Pin Assignments*, refer to page 33.

For *Potentiometer Sensor with Analog Output Pin Assignments*, refer to page 34.

For *Hall Effect Sensor with Analog Output Pin Assignments*, refer to page 35.

Pin Assignments

CAN Output Connector Pin Assignments

Pinout and Wiring Information

Pin	CAN output
1	Ground
2	Power
3	CAN high
4	CAN low
5	CAN shield
6	No connection

Pin Location

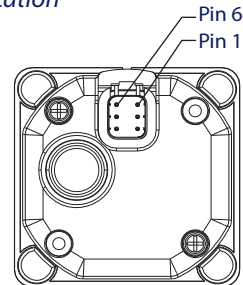

2239

CAN Output Mating Connector Deutsch® DTM06-6S

Sauer-Danfoss provides mating connector kits (bag assemblies) for JS6000 joysticks. The bag assembly contains loose parts you must assemble. The connector with wire harness features a fully assembled connector with an unterminated wire harness.

Mating Connector Assemblies

Type	Sauer-Danfoss material number
Connector bag assembly	10101551
Connector with 400 mm [15.75 in] wire harness	10101557

**Pin Assignments
 (continued)**

CAN+ and PWM Output Connector Pin Assignments

Pin Location

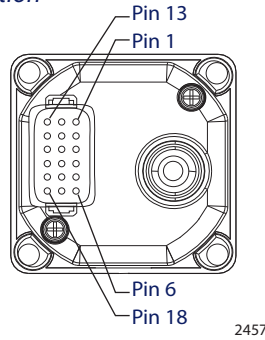

*CAN+ Output Connector
 Pinout and Wiring Information*

Pin	CAN output
1	Ground -
2	Power +
3	CAN high
4	CAN low
5	CAN shield
6	Operator present/DIN11
7	Sensor ground -
8	5 Vdc sensor power +
9	AIN1/DIN7
10	AIN2/DIN8
11	AIN3/DIN9
12	AIN4/DIN10
13	DIN1
14	DIN2
15	DIN3
16	DIN4
17	DIN5
18	DIN6

*PWM Output Connector
 Pinout and Wiring Information*

Pin	CAN output
1	Ground -
2	Power +
3	CAN high
4	CAN low
5	PWM Valve Out 1 +
6	PWM Valve Out 1 -
7	PWM Valve Out 2 +
8	PWM Valve Out 2 -
9	AIN / CAN Shield
10	DIN
11	DOUT1
12	DOUT2
13	DOUT3
14	DOUT4
15	Operator Presence +
16	Operator Presence -
17	DOUT5
18	DOUT6

Caution

Joystick electronics damage may occur possibly causing the joystick to non-function. Do not connect battery power to operator presence + or operator presence -.

CAN+ and PWM Output Mating Connector Deutsch® DT16-18SB

Sauer-Danfoss provides mating connector kits (bag assemblies) for JS6000 joysticks. The bag assembly contains loose parts you must assemble. The connector with wire harness features a fully assembled connector with an unterminated wire harness.

Mating Connector Assemblies

Type	Sauer-Danfoss material number
Connector bag assembly	11012648
Connector with 400 mm [15.75 in] wire harness	11012646

**Pin Assignments
 (continued)**

Potentiometer Sensor with Analog Output Connector Pin Assignments

Pin Location

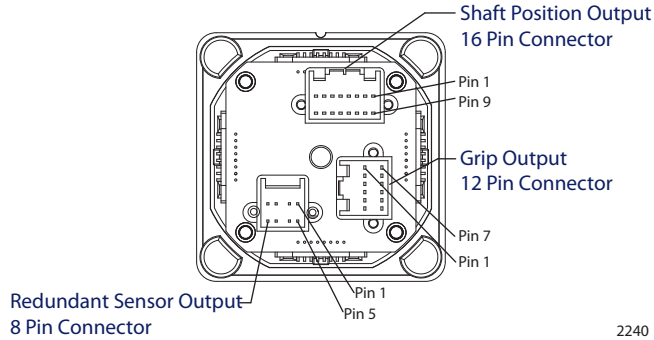

2240

*16 Pin Sensor Connections**

Pin	Pin allocation description
1	N/O signal Y-axis direction switch forward
2	N/C signal X-axis direction switch center
3	X-axis ground
4	X-axis position signal
5	X-axis + supply voltage
6	X-axis center tap + supply voltage
7	X-axis direction switches + supply voltage
8	N/O signal X-axis direction switch left
9	Y-axis ground
10	Y-axis position signal
11	Y-axis + supply voltage
12	Y-axis center tap + supply voltage
13	Y-axis direction switches + supply voltage
14	N/O signal Y-axis direction switch back
15	N/O signal X-axis direction switch right
16	N/C signal Y-axis direction switch center

8 Pin Redundant Sensor Connections

Pin	Pin allocation description for redundant potentiometer sensor
1	Second Y axis + supply voltage
2	Second Y-axis center tap + supply voltage
3	Second Y-axis position signal
4	Second Y-axis ground
5	Second X-axis + supply voltage
6	Second X-axis position signal
7	Second X-axis center tap + supply voltage
8	Second X-axis ground

For 12 pin grip output connections see Sauer-Danfoss manual *JS1000, JS6000 Joystick Grips Technical Information 520L0872* for grip connector pin out assignments.

* Refer to page 10 for additional details referencing potentiometer measurement and switch track connections.

Analog Output Mating Connector

Sauer-Danfoss provides mating connector kits (bag assemblies) for JS6000 joysticks. The bag assembly contains loose parts you must assemble. The connector with 400 mm leads features a fully assembled connector with an unterminated wire harness.

Bag Assemblies

Type	Sauer-Danfoss material number
16 pin + contacts	10101552
12 pin + contacts	10101020
8 pin + contacts	10101022
12 + 8 pin + contacts	10101023

Wire Harness

Type	Sauer-Danfoss material number
16 pin with 400 mm [15.75 in] leads	10101556
12 pin with 400 mm [15.75 in] leads	10101555
8 pin with 400 mm [15.75 in] leads	10101554

**Pin Assignments
 (continued)**

Hall Effect Sensor with Analog Output Pin Assignments

Pin Assignments

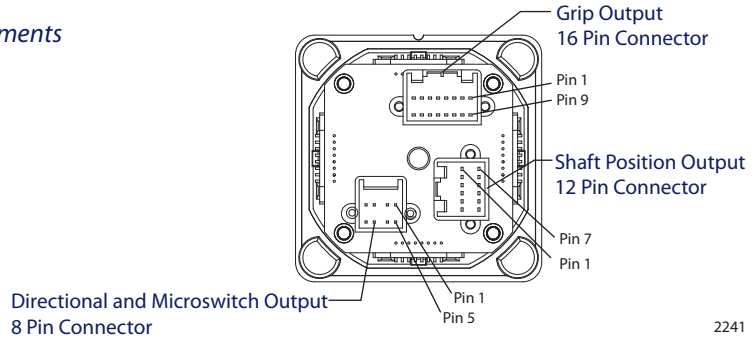

2241

12 Pin Shaft Position Connections

Pin	Pin allocation description
1	Hall 3 and 4 5 Vdc + supply
2	Hall 3 and 4 ground
3	Hall 1 and 2 5 Vdc + supply
4	Hall 1 and 2 ground
5	Hall 3 forward/backward output
6	Hall 2 left/right output
7	Hall 4 left/right output
8	Hall 1 forward/backward output
9	Not connected
10	Not connected
11	Not connected
12	Not connected

8 Pin Microswitch and Directional Switch Connections

Pin	Pin allocation description
1	Joystick forward common
2	Forward switch output
3	Backward switch output
4	Switch backward common
5	Switch left common
6	Left switch output
7	Right switch output
8	Switch right common

For 12 pin grip output connections see Sauer-Danfoss manual *JS1000, JS6000 Joystick Grips Technical Information 520L0872*, for grip connector pin out assignments.

Mechanical Characteristics

Mechanical Characteristics

Shaft mechanical angle limits	± 20°
Shaft maximum overload	5 cycles only at 490 N [110.15 lbf] measured 130 mm [5.12 in] above mounting surface
Shaft maximum operating load	390 N [87.67 lbf] measured 130 mm [5.12 in] above mounting surface
Shaft maximum downward loading	2450 N [550.76 lbf]
Shaft maximum torque	15 N·m [11.06 lbf·ft]
Base mechanical life (X and Y axis only)	> 7.5 million operating cycles
Base only mass	0.75 kg [1.65 lbf]

Breakout Load On Axis

Medium duty spring	6 to 8.5 N [1.349 to 1.911 lbf]
Heavy duty spring	12 to 19 N [2.698 to 4.271 lbf]

Load At Full Deflection

Medium duty spring	15 to 23 N [3.37 to 5.17 lbf]
Heavy duty spring	31 to 47 N (6.97 to 10.57 lbf)

Electrical Characteristics

Potentiometer Sensor with Analog Output

Supply voltage (Vs)	9 to 36 Vdc
Maximum survival voltage	36 Vdc
Maximum wiper current	5 mA
Maximum load current	200 mA resistive
Center tap/switch alignment	Within 0.5°
Potentiometer electrical angle	± 18°
Center tap angle	± 2.5°
Insulation resistance at 50 Vdc	> 50 MΩ
Minimum load impedance	1 MΩ recommended

Potentiometer Output Options

Minimum voltage (% Vs)	Maximum voltage (% Vs)	Switch track angle (°)	Resistance (kΩ)	Model code order character
10 ± 2	90 ± 2	± 1.5	1.6 to 2.4	R
25 ± 2	75 ± 2	± 1.5	2.2 to 3.6	Q
10 ± 2	90 ± 2	± 5	1.6 to 2.4	S
25 ± 2	75 ± 2	± 5	2.2 to 3.6	T

Dual Potentiometer Output

Minimum voltage (% Vs)	Maximum voltage (% Vs)	Switch track angle (°)	Resistance (kΩ)	Model code order character
10 ± 2	90 ± 2	± 1.5	1.6 to 2.4	U

**Electrical Characteristics
 (continued)**

Hall Effect Sensor with Analog Output

Supply voltage (Vs)	5 ± 0.5 Vdc
Maximum survival supply voltage	18 Vdc
Maximum current draw (base only)	90 mA
Minimum output voltage	10% ± 4% Vs
Center voltage	50% ± 2% Vs
Maximum output voltage	90% ± 4% Vs

Hall Effect Sensor with CAN Output Option

Supply voltage (Vs)	9 to 36 Vdc
Maximum current draw (base only)	90 mA

Supports CAN 2.0B with SAE J1939 message protocol

Hall Effect Sensor with PWM Output Option

Supply voltage (Vs)	9 to 36 Vdc
Maximum survival voltage	40 Vdc
Maximum current draw (base only)	13 amps
Valve outputs	2.5 amps maximum
Digital outputs	3.0 amps maximum
Maximum output current	13.0 amps

External-To-Joystick Digital Inputs

Property	Minimum	Maximum	Comments
Allowed voltage at pin	0 Vdc	36 Vdc	
Rising voltage threshold	2.48 Vdc	3.5 Vdc	Digital input will be read as high if voltage is greater than 3.5 Vdc
Falling voltage threshold	1 Vdc	2.25 Vdc	Digital input will be read as low if voltage is less than 1 Vdc
CAN output latency	6 ms	24 ms	Based on update rate of application software
Response to voltage below minimum			Non-damaging, non-latching; reading saturates to low limit
Response to voltage above maximum			Non-damaging; non-latching; reading saturates to high limit

External-To-Joystick Analog Inputs

Property	Minimum	Maximum	Comments
Allowed voltage at pin	0 Vdc	36 Vdc	
	0 Vdc	25 Vdc	AIN/CAN_Shld on PWM version
Maximum discernable voltage	4.915 Vdc	5.085 Vdc	
Minimum discernable voltage	0 mVdc	85 mVdc	
Response to input below minimum voltage			Effect on other inputs; non damaging, non-latching; reading saturates to low limit
Response to input above maximum voltage			Effect on other inputs; non damaging, non-latching; reading saturates to high limit
Response to open input			Pull down = 0 Vdc

**Microswitch
 Characteristics**

Microswitch Characteristics

Mechanical deflection	0 to 5°
Contact ratings	3 A at 125 V AC, 2 A at 30 Vdc
Service life	100,000 cycles minimum at a cycling frequency of 1 Hz at 1 A 12 Vdc

**Sensor Power Supply
 Ratings**

Sensor Power Supply Ratings

Property	Minimum	Maximum	Comments
Output current		50 mA	
Output voltage	4.85 Vdc	5.15 Vdc	
Output short circuit voltage		36 Vdc	

**Environmental
 Characteristics**

Environmental Characteristics

Operating temperature		-40°C to +80°C [-40°F to 176°F] with microswitches: -25°C to 80°C [-13°F to +176°F]
Storage temperature		-40°C to +85°C [-40°F to 185°F] with microswitches: -25°C to +80°C [-13°F to +176°F]
Joystick base Ingress Protection (IP) rating		Potentiometer: IP 40 below panel (grip dependent above) Hall: IP 40 below panel (grip dependent above) CAN, CAN+, PWM: IP 66 below panel (grip dependent above)
EMI/RFI Rating		100 V/m
Vibration (sinusoidal)	Level 3.6 G rms	Frequency range 10 to 200 Hz (Duration 2 hours each axis)
	Level ± 3 G Peak	Frequency range 10 to 200 Hz (Duration 1 hour each axis random)
Shock		Level 20 G type 1/2 sine 6 ms Number of shocks: 1350 each axis



JS6000 Joystick Base
Technical Information
Notes

Our Products

Open circuit axial piston pumps
 Gear pumps and motors
 Fan drive systems
 Closed circuit axial piston pumps and motors
 Bent axis motors
 Hydrostatic transmissions
 Transit mixer drives
 Hydrostatic transaxles
 Electrohydraulics
 Integrated systems
 Microcontrollers and software
 PLUS+1™ GUIDE
 Displays
 Joysticks and control handles
 Sensors
 Orbital motors
 Inverters
 Electrohydraulic power steering
 Hydraulic power steering
 Hydraulic integrated circuits (HIC)
 Cartridge valves
 Directional spool valves
 Proportional valves

Sauer-Danfoss Mobile Power and Control Systems – Market Leaders Worldwide

Sauer-Danfoss is a comprehensive supplier providing complete systems to the global mobile market.

Sauer-Danfoss serves markets such as agriculture, construction, road building, material handling, municipal, forestry, turf care, and many others.

We offer our customers optimum solutions for their needs and develop new products and systems in close cooperation and partnership with them.

Sauer-Danfoss specializes in integrating a full range of system components to provide vehicle designers with the most advanced total system design.

Sauer-Danfoss provides comprehensive worldwide service for its products through an extensive network of Global Service Partners strategically located in all parts of the world.

Local address:

Sauer-Danfoss (US) Company
 2800 East 13th Street
 Ames, IA 50010, USA
 Phone: +1 515 239-6000
 Fax: +1 515 239 6618

Sauer-Danfoss GmbH & Co. OHG
 Postfach 2460, D-24531 Neumünster
 Krokamp 35, D-24539 Neumünster, Germany
 Phone: +49 4321 871-0
 Fax: +49 4321 871 122

Sauer-Danfoss ApS
 DK-6430 Nordborg, Denmark
 Phone: +45 7488 4444
 Fax: +45 7488 4400

Sauer-Danfoss-Daikin LTD.
 Shin-Osaka TERASAKI 3rd Bldg. 6F
 1-5-28 Nishimiyahara, Yodogawa-ku
 Osaka 532-0004, Japan
 Phone: +81 6 6395 6066
 Fax: +81 6 6395 8585