

Technical
Information

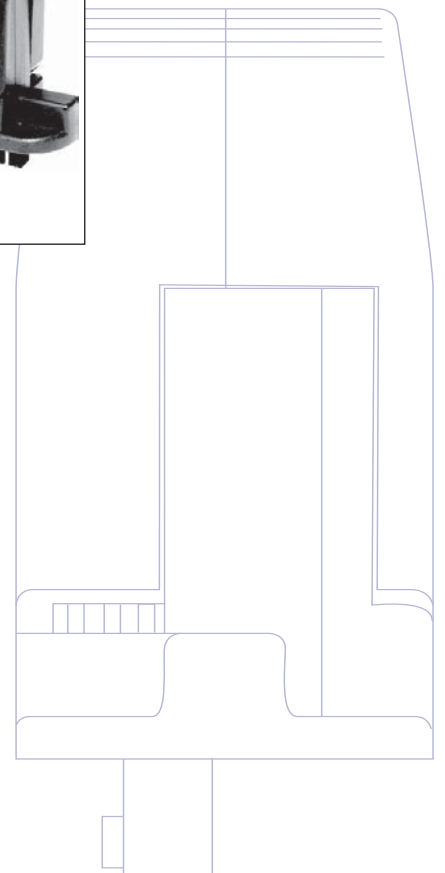
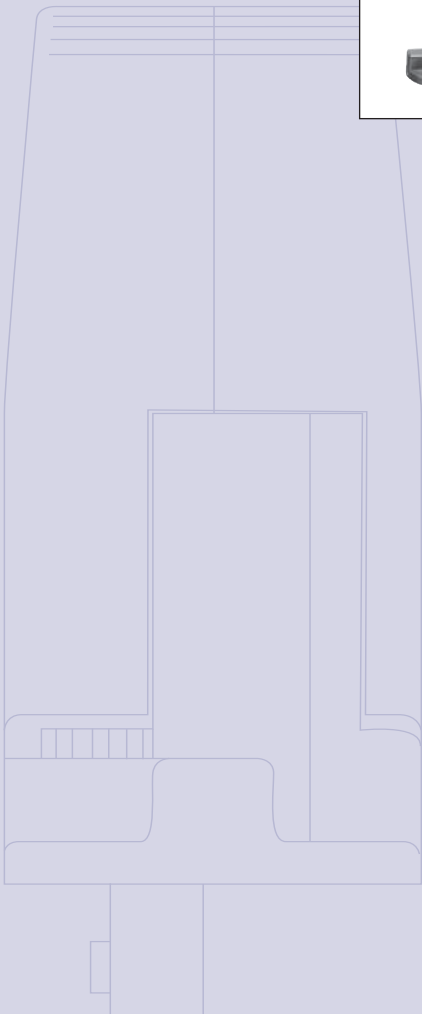
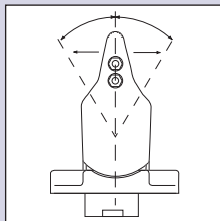
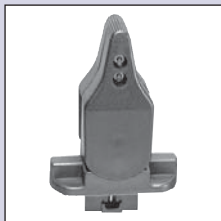

Version*Revisions*

Date	Page	Change	Rev.
2 July, 2009	8, 11	Corrected connector pin assignments and added output voltage curve	DA
13 Feb, 2007		Lever length options; connector pin assignments	CA
12 May, 2006	7	Model code number	B
9 May, 2006	5	Typical contact resistance to ohms	A

© 2009 Sauer-Danfoss. All rights reserved.

Sauer-Danfoss accepts no responsibility for possible errors in catalogs, brochures and other printed material. Sauer-Danfoss reserves the right to alter its products without prior notice. This also applies to products already ordered provided that such alterations can be made without affecting agreed specifications. All trademarks in this material are properties of their respective owners. Sauer-Danfoss, the Sauer-Danfoss logotype, the Sauer-Danfoss S-icon, PLUS+1™, What really matters is inside® and Know-How in Motion™ are trademarks of the Sauer-Danfoss Group.

Front cover illustrations: 2282, 2284, 2283, F005202, 2285

General Information	Product Overview	4
	Features and Options.....	4
Product Configuration	Product Configuration Model Code	5
Product Installation	Dimensions and Mounting	7
	Connector Pin Assignments	8
	Mating Connector Details	8
	Recommended Wiring Practice.....	9
	Installation Notes	10
Product Specifications	Mechanical Characteristics	11
	Electrical Characteristics	11
	Environmental Characteristics.....	11

Product Overview

The JS120 Joystick has been developed to meet the harsh operating requirements of today's mobile machine market. Developed for applications where ergonomics and system integrity are paramount, the JS120 is a minimum width, low profile joystick that provides precise fingertip control in one axis. The low profile lever makes the JS120 less susceptible to unintentional operation and the minimum under-panel footprint makes it ideal for mounting in panels and operator arm rests. The JS120 is sealed to IP 66 above panel to enable it to operate in extreme environments.

Designed for use with electronic controllers, the joystick generates analog and switched reference signals proportional to the distance and direction over which the handle is moved. The output is configured to provide signals for fault detection circuits and a center tap provides an accurate voltage reference for the lever in its released position, or a zero point for a bipolar supply voltage. Electrically independent direction switches are also available.

This publication describes the technical features and data required to specify the JS120 base for your application.

Features and Options

- Single axis
- Spring return to center
- Spring return to one end of travel
- Width only 26.5 mm (1.04 in)
- Ergonomic design
- Choice of two lever heights
- Sealed to IP 66, above panel
- Choice of output voltage ranges
- Center switch
- Direction switches

Product Configuration Model Code

The JS120 Product Configuration Model Code (model code) lists the various options for the JS120. The model code begins with the product family name, JS120, followed by the variant code for the desired options.

Model Code Summary

Product Configuration Model Code

A					B			
J	S	1	2	0	0	0	0	2

A Product Series

Code	Description
JS120	Series JS120 Joystick

B Lever Length and Output Voltage Range Options

	Code	Description
	0002	Short lever, 10 to 90% Vs output range, 5 kΩ, spring return to center
	0003	Short lever, 25 to 75% Vs output range, 5 kΩ, spring return to center
	0005	Long lever, 10 to 90% Vs output range, 5 kΩ, spring return to center
	0006	Long lever, 25 to 75% Vs output range, 5 kΩ, spring return to center
	0008	Long lever, 10 to 90% Vs output range, 5 kΩ, spring return to end
	0009	Long lever, 25 to 75% Vs output range, 5 kΩ, spring return to end
	0010	Short lever, 10 to 90% Vs output range, 5 kΩ, spring return to end
	0011	Short lever, 25 to 75% Vs output range, 5 kΩ, spring return to end

Vs = supply voltage

Product Configuration
Model Code
(continued)

Center Tap (Spring Return to Center Option)

A center tap is a standard JS120 feature, where 50% of the supply voltage can be supplied to force the sensor voltage to this known reference. When the center tap is not connected there will be a center dead band (where the voltage output does not change on initial deflection).

Padding Resistors

The JS120 potentiometer track has resistors placed in series with the main resistive element. These resistors are used to reduce the outputs at full mechanical deflection. This is a safety feature that the machine control system can use to determine a broken wire or short circuit to full voltage or ground. The degree to which the output is reduced can be chosen from *Code B table*, page 4.

Position Switches

Position switches are a standard JS120 feature. The normally open switches close at the angles specified in the table below indicating forward and reverse travel of the lever. These switches are connected independently of the proportional potentiometric elements and can be terminated by the customer to provide center on/off data to the control system.

Specifications

Switch operating angle	5° either side of center ($\pm 1^\circ$ tolerance)
Maximum supply voltage—maximum Vs	< 35 Vdc
Minimum load resistance	10 k Ω
Maximum load current	2 mA resistive
Typical contact resistance	150 Ω

Dimensions and Mounting

Installation Dimensions in Millimeters [Inches]

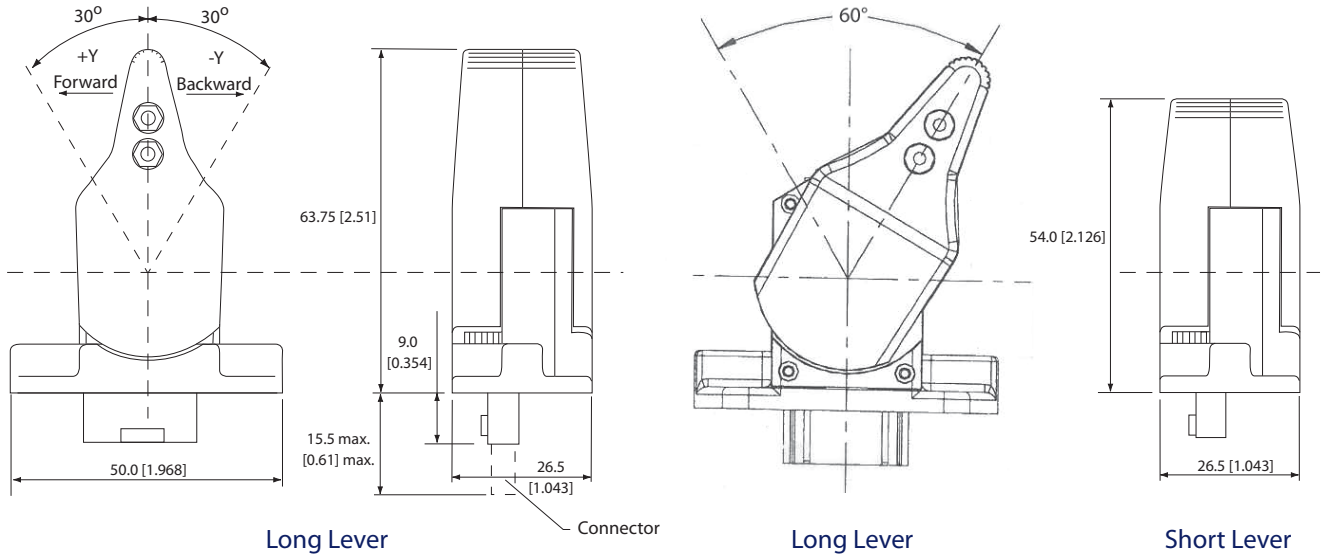

Joystick fitted with 2 x M3 inserts
 Maximum screw penetration 6 [0.236]

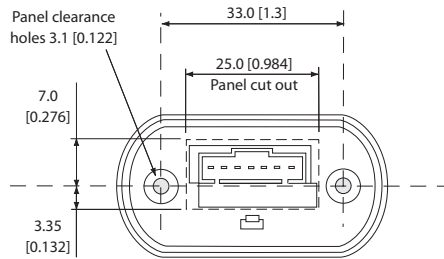

P005290

The JS120 is designed to be fitted down into the panel, through the panel cutout, shown in *dimensions and mounting*, above.

Panel seal integrity can be achieved by using sealing gasket. Mounting screws can be driven to a recommended torque of 1 N·m (9 lbf·in). The joystick is fitted with 2 x M3 inserts and the maximum screw penetration is 6 mm (0.24 in) plus panel thickness.

Connector Pin Assignments

Pinout and Wiring Information

Bottom view, joystick connector		JS120-0002, 0003, 0005, 0006	JS120-0008, 0009, 0010, 0011
	G Pin 1	Direction switch common	Direction switch common
	F Pin 2	Direction switch +Y (N/O)	Direction switch (N/O)
	E Pin 3	Direction switch -Y (N/O)	Not used
	D Pin 4	(-) supply (ground)	(-) supply (ground)
	C Pin 5	Output voltage	Output voltage
	B Pin 6	(+) supply (power)	(+) supply (power)
	A Pin 7	Center tap	Not used

Mating Connector Details

Mating Connector – AMP MODU MTE Series

Connector	AMP ordering number
7 pin latching male	103957-6

Mating Connector Assembly

Type	Sauer-Danfoss ordering number
7 pin with 610 mm [24.02 in] leads	10101762

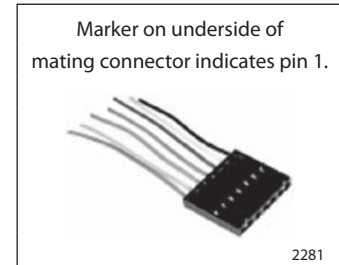

**Recommended Wiring
Practice**

- All wires must be protected from mechanical abuse.
- Use 85° C wire with abrasion resistant insulation.
- Separate high current wires such as solenoids, lights, alternators, or fuel pumps from control wires. Recommended minimum separation is 300 mm [11.8 in].
- Run wires along the inside of or close to metal machine frame surfaces where possible. This simulates a shield which will minimize the effects of EMI/RFI radiation.
- Do not run wires near sharp metal corners. Consider running wire through grommets when rounding a corner.
- Provide strain relief for all wires.
- Avoid running wires near moving or vibrating components.
- Avoid long, unsupported wire spans.
- All sensors have dedicated wired power sources and ground returns. They should be used.
- Sensor lines should be twisted about one turn every 100 mm [3.94 in].
- It is better to use wire harness anchors that will allow wires to float with respect to the machine frame rather than rigid anchors.

Installation Notes

- The joystick is sealed above the mounting surface to prevent dust and water ingress and is supplied with a sealing gasket for mounting above the panel. The effectiveness of the seal is dependent on the mounting surface being sufficiently rigid to compress the sealing gasket. The finish of the mounting surface is critical to achieving an adequate seal and rough surface finishes, paint chips, deep scratches, etc should be avoided.
- The joystick base below the mounting surface should be protected from dust and direct water spray.

Joystick Safety

For a system to operate safely it must be able to differentiate between commanded and uncommanded inputs. System designers should take steps to detect and manage joystick and system failures that may cause an erroneous output.

For safety critical functions it is recommended that an independent momentary action *system enable* switch be used. This switch can be incorporated into the joystick as a *operator present* switch or can be a separate foot or hand operated momentary switch. All functions controlled by the joystick should be disabled when this switch is released.

The control system should look for the appropriate *system enable* switch input before the joystick is displaced from its neutral position. Functions enabled by the joystick should not be enabled until this input is received.

Mechanical Characteristics

Mechanical

Lever type	Short lever	Long lever
Breakout force (at lever tip)	3.1 N [0.70 lbf]	2.3 N [0.52 lbf]
Operating force (at tip, full deflection)	5.1 N [1.15 lbf]	3.4 N [0.76 lbf]
Maximum allowable force	50 N [11.24 lbf]	35 N [7.87 lbf]
Lever operating angle	30° ± 1° center return 60° ± 1° end return	
Lever action	Self centering or end return	
Expected life	> 5 million cycles	
Weight	0.045 kg [0.099 lb]	

Electrical Characteristics

Electrical

Sensor type	Potentiometric
Electrical angle of movement center return	28° ± 1°
Electrical angle of movement end return	Start 2° ± 1°, end return full angle 56° ± 1°
Total track resistance	5 kΩ (± 20%)
Maximum supply voltage (Vs)	35 Vdc
Maximum wiper current	5 mA (non-destructive)
Maximum power dissipation	0.25 W at 20°C [68°F]
Wiper circuit impedance	200 kΩ minimum
Output voltage	10 to 90% Vs 25 to 75% Vs
Resolution	Infinite
Center tap voltage (no load)	50% Vs ± 2%
Center tap angle (center return)	± 2.5° either side of center (± 1° tolerance)
Insulation resistance	> 50 MΩ at 500 Vdc
Load resistance minimum	10 kΩ
Load current maximum	2 mA resistive

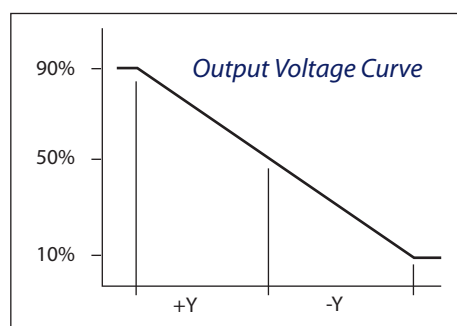

P108023

Environmental Characteristics

Environmental

Operating temperature	-25°C to 70°C [-13°F to 158°F]
Storage temperature	-40°C to 85°C [-40°F to 185°F]
Environmental sealing above the flange	IP 66 above panel, IP 40 below panel



Products we offer:

- Bent Axis Motors
- Closed Circuit Axial Piston Pumps and Motors
- Displays
- Electrohydraulic Power Steering
- Electrohydraulics
- Hydraulic Power Steering
- Integrated Systems
- Joysticks and Control Handles
- Microcontrollers and Software
- Open Circuit Axial Piston Pumps
- Orbital Motors
- PLUS+1™ GUIDE
- Proportional Valves
- Sensors
- Steering
- Transit Mixer Drives

Members of the Sauer-Danfoss Group:

Comatrol

www.comatrol.com

Schwarz Müller-Inverter

www.schwarzmueller-inverter.com

Turolla

www.turollaocg.com

Hydro-Gear

www.hydro-gear.com

Sauer-Danfoss-Daikin

www.sauer-danfoss-daikin.com

Sauer-Danfoss is a global manufacturer and supplier of high-quality hydraulic and electronic components. We specialize in providing state-of-the-art technology and solutions that excel in the harsh operating conditions of the mobile off-highway market. Building on our extensive applications expertise, we work closely with our customers to ensure exceptional performance for a broad range of off-highway vehicles.

We help OEMs around the world speed up system development, reduce costs and bring vehicles to market faster.
Sauer-Danfoss – Your Strongest Partner in Mobile Hydraulics.

Go to www.sauer-danfoss.com for further product information.

Wherever off-highway vehicles are at work, so is Sauer-Danfoss.

We offer expert worldwide support for our customers, ensuring the best possible solutions for outstanding performance. And with an extensive network of Global Service Partners, we also provide comprehensive global service for all of our components.

Please contact the Sauer-Danfoss representative nearest you.

Local address:

Sauer-Danfoss (US) Company
2800 East 13th Street
Ames, IA 50010, USA
Phone: +1 515 239 6000
Fax: +1 515 239 6618

Sauer-Danfoss ApS
DK-6430 Nordborg, Denmark
Phone: +45 7488 4444
Fax: +45 7488 4400

Sauer-Danfoss GmbH & Co. OHG
Postfach 2460, D-24531 Neumünster
Krokamp 35, D-24539 Neumünster, Germany
Phone: +49 4321 871 0
Fax: +49 4321 871 122

Sauer-Danfoss-Daikin LTD.
Shin-Osaka TERASAKI 3rd Bldg. 6F
1-5-28 Nishimiyahara, Yodogawa-ku
Osaka 532-0004, Japan
Phone: +81 6 6395 6066
Fax: +81 6 6395 8585