

Technical  
Information

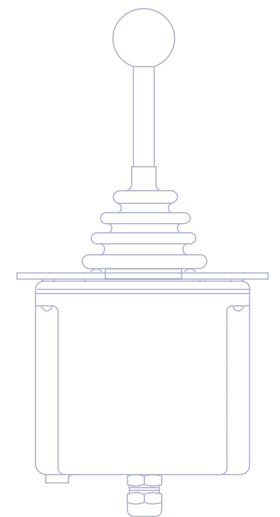
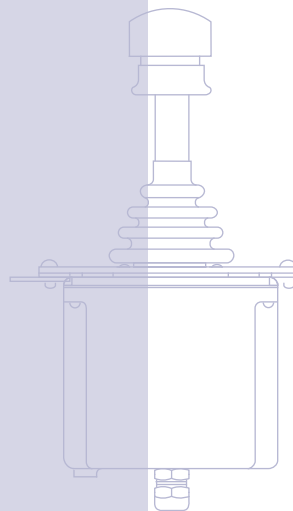
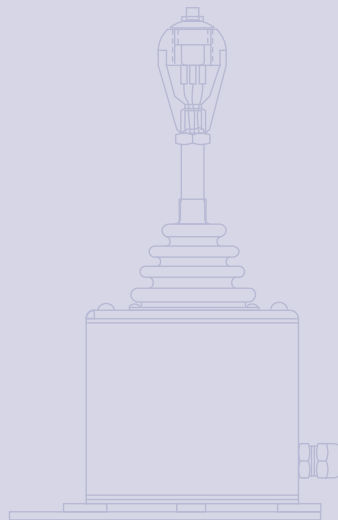
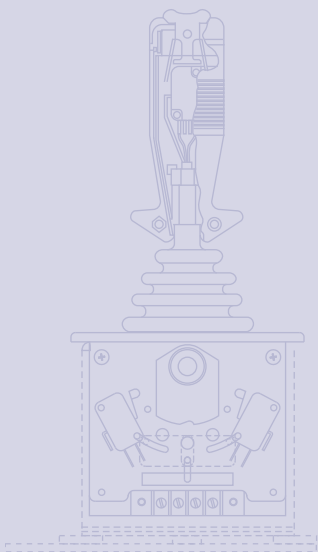

**Version**

*Revisions*

<b>Date</b>	<b>Page</b>	<b>Changed</b>	<b>Rev.</b>
03 Jan, 2011	12	Added new line item to table and deleted a line item	EA
14 May, 2010	12	MCHXXX Potentiometer Models with 1K Ohm table updated.	DA
03 Feb, 2010	12	MCHXXX Potentiometer Models with 1K Ohm table updated.	CA
10 Aug, 2009	12	MCHXXX Potentiometer Models with 1K Ohm table updated.	BA
30 Jan, 2009	13	Corrected operating and storage temperature.	AB
18 Dec, 2008	Various pages	Updated BLN-95-8956 to Technical Information (TI) format; and various content updated.	AA

© 2011 Sauer-Danfoss. All rights reserved.

Sauer-Danfoss accepts no responsibility for possible errors in catalogs, brochures and other printed material. Sauer-Danfoss reserves the right to alter its products without prior notice. This also applies to products already ordered provided that such alterations can be made without affecting agreed specifications. All trademarks in this material are properties of their respective owners. Sauer-Danfoss, the Sauer-Danfoss logotype, the Sauer-Danfoss S-icon, PLUS+1™, what really matters is inside® and Know-How in Motion™ are trademarks of the Sauer-Danfoss Group.

Front cover illustrations: F101733, F101732, F101731, 2452, 2453

<b>Product Overview</b>	Description .....	4
	Features .....	4
	Ordering Information.....	4
	Mounting.....	6
	Type of Control Knob.....	6
	Handle Actuation.....	7
	Electrical Characteristics.....	7
	Connector.....	8
	Suffix number.....	8
	Dimensions.....	9
	Connectors .....	9
<b>Technical Data</b>	Specifications.....	10
	Connection Diagrams .....	11
	Potentiometer Option .....	11
	Potentiometer Option with 1K Ohm Potentiometer .....	12
	PWM Option (primarily).....	13
	Environmental Testing.....	13
<b>Wiring Information</b>	Wiring .....	14
<b>Device Repair</b>	Return To .....	16

### Description

The MCHXXX Single Axis Control Handle provides remote electrical actuation of Sauer-Danfoss pumps/motors, and or other electrically-actuated pump strokers for open loop control systems. The MCHXXX can function as a setpoint for analog or microprocessor-controlled systems for controlling position, speed, pressure, horsepower or other dynamic parameters.

### Features

Shock and vibration resistant  
Choice of three mounting styles, with or without watertight case  
Rugged components designed for the construction environment  
High-torque handle actuation gives sure feel  
Simple to install  
Mechanical options include center-lock, spring-return, friction drag, uni/bi-directionality and optional wire harness with a variety of electrical connectors  
Electrical characteristics customized to the application

### Ordering Information

A wide range of options to the basic control handle allow custom-tailoring to each application. See the *Ordering Specification Chart*, page 5, for assistance in determining model number. Other options are possible; consult Sauer-Danfoss with further questions.

**Ordering Information  
 (continued)**

*Ordering Specification Chart*

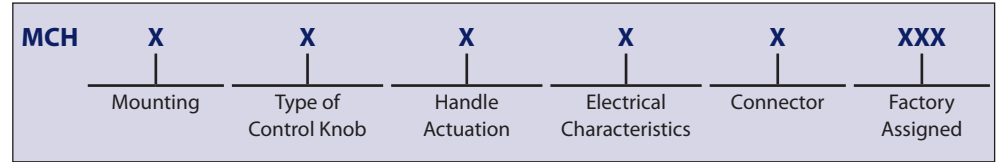

*Mounting*

Code	Description
<b>1</b>	Base (surface) mount aluminum case
<b>2</b>	Top mount (drop in) with plastic case
<b>3</b>	Top mount (drop in) without case
<b>4</b>	Panel mount with plastic case
<b>5</b>	Panel mount without case

*Type of Control Knob*

Code	Description
<b>1</b>	Non-locking
<b>2</b>	Center lock
<b>3</b>	Non-locking, auxiliary push button switch
<b>5</b>	Non-locking, no knob
<b>6</b>	Three position maintained rocker switch
<b>8**</b>	Special (no handle or knob)
<b>9</b>	Three position momentary rocker switch

\*\* Unique configuration.

*Handle Actuation*

Code	Description
<b>A</b>	Spring return, bi-directional
<b>B</b>	Friction held, bi-directional
<b>C</b>	Friction held, uni-directional
<b>D</b>	Special (friction held, center detent only, no brake)

*Electrical Characteristics*

Code	Description
<b>A</b>	Proportional, no switches, 12 Vdc
<b>B</b>	Proportional, center off switch, 12 Vdc,
<b>C</b>	Proportional, center off switch, 24 Vdc
<b>D</b>	Proportional, center off and auxiliary switch, 12 Vdc
<b>E</b>	Proportional, set-point potentiometer, 12 Vdc
<b>F</b>	Step-plus-proportional, 12 Vdc
<b>G</b>	Step-plus-proportional, 24 Vdc
<b>H</b>	Switching
<b>J</b>	Step-plus-proportional, full auxiliary switching, 12 Vdc
<b>K</b>	Proportional, unwired switch
<b>L*</b>	Electronic PWM auxiliary switching, 12 Vdc
<b>M</b>	Proportional, three switches
<b>X**</b>	Special
<b>Y**</b>	Special
<b>Z**</b>	Special

\* **Option L** will no longer be available starting in 2008 as it nears the end of its life cycle.

\*\* Unique configuration.

*Connector*

Code	Description
<b>1</b>	Terminal strip
<b>2</b>	Pigtail 1524 mm [60 in] without connector
<b>3</b>	Pigtail with unsealed Delphi™ connector
<b>6</b>	Pigtail with sealed Delphi connector, 4 pin male and female
<b>7</b>	Pigtail sealed Delphi connector
<b>8</b>	Pigtail sealed Deutsch® connector

For details regarding unique configurations, contact your Sauer-Danfoss representative.

**Ordering Information  
(continued)****Mounting****1 Base (surface) mount aluminum case**

Four screws connect to the flanges on the bottom of the metal case.

**2 Top mount with (drop in) with plastic case**

Two screws connect to an enlarged mounting plate. Top mounting allows the entire handle to be removed from above the panel. The case is made of black nylon plastic.

**3 Top mount (drop in) without case**

Two screws connect to an enlarged mounting plate. Top mounting allows the entire handle to be removed from above the panel.

**4 Panel mount with plastic case**

Four screws connect to the top plate that holds the boot in place. The case is made of black nylon plastic.

**5 Panel mount without case**

Four screws connect to the top plate that holds the boot in place.

**Type of Control Knob**

---

Reference *Dimensions*, page 9.

---

**1 Non-locking**

The non-locking handle has a standard ball knob. The friction-held handle detents with a spring-loaded ball to indicate null, while the spring-return handle has a spring preload indicating null.

**2 Center lock**

The center lock handle has a cylindrical knob and provides a positive center lock that unlatches when the operator pulls up on the knob.

**3 Non-locking, auxiliary push-button switch**

This knob is teardrop shaped, with an auxiliary momentary push-button switch on top. The switch is wired through the handle shaft to the body with three wires (common, normally open, and normally closed).

**5 Non-locking, no knob**

The customer provides customized knob.

**6 Three position maintained rocker switch**

The cylindrical knob has a boot covering the three-position switch in the knob. The switch, wired through the handle, is used for auxiliary functions.

**9 Three position momentary rocker switch**

This is the same as option 6, but the switch returns to the center position when released.

**Ordering Information  
(continued)**

**Handle Actuation**

*A Spring return, bi-directional*

This handle uses a torsion spring to return to the mechanical center position and has 30 degrees of handle throw on either side of center.

*B Friction held, bi-directional*

This handle has an adjustable drag, set with a clamp-type brake that holds the handle at the set position and has 30 degrees of handle throw on either side of the center detent.

*C Friction held, uni-directional*

This handle has 60 degrees of high-resolution of handle throw, rotating on only one side of mechanical null, which is at full stroke. It has no detent mechanism.

**Electrical Characteristics**

*A Proportional, no switches, 12 Vdc*

This handle's output curve is fairly linear, with output voltage as a function of handle stroke (see *Proportional Control Handle*, page 9). The supply voltage is 12 Volts, and there are no auxiliary function switches.

*B Proportional, center-off switch, 12 Vdc*

This handle has a center-off switch that ensures zero output voltage within  $\pm 3$  degrees of handle center position.

*C Proportional, center-off switch, 24 Vdc*

Same as option B except this handle runs on a supply voltage of 24 Volts.

*D Proportional, center-off and auxiliary switch, 12 Vdc*

Same as option B except this handle has a second switch that actuates at +2 or -2 degrees.

*E Proportional, set-point potentiometer, 12 Vdc*

Same as option B except this handle maintains the same polarity of signal in forward or reverse.

*F Step-plus-proportional, 12 Vdc*

This handle uses two switches to give the step-plus-proportional output current on either side of null. This overcomes deadbands in spool valves (see *Step-Plus-Proportional-Control-Handle PWM Handle*, page 10). Current beyond this step output is proportional through the rest of the handle throw. Full current output at 30 degrees handle stroke is maximum of 250 mA. Step current is a maximum of 50% of full current output.

*G Step-plus-proportional, 24 Vdc*

Same as option F, except this handle runs on a supply voltage of 24 Vdc.

*H Switching*

This handle is non-proportional. Moving the handle off null activates switches that power ON/OFF devices (solenoid valves for example).

*J Step-plus-proportional, full auxiliary switching, 12 Vdc*

This handle uses the step switches for additional secondary functions. Full current output at 30 degrees handle stroke is a maximum of 250 mA. Step current is a maximum of 50% of full current output.

#### Ordering Information (continued)

---

**Option L** will no longer be available starting in 2008 as it nears the end of its life cycle.

---

---

For optional connectors, contact your Sauer-Danfoss representative.

---

---

Pigtail (or leadwire) are routed from the control handle to a Delphi environmental connector. Pigtail minimum length is 381 mm [15 in].

---

---

For details regarding unique configurations, contact your Sauer-Danfoss representative.

---

#### *K Proportional, unwired switch*

The customer uses the unwired center switch to operate an auxiliary function, such as neutral start interlock.

#### *L Electronic PWM auxiliary switching, 12 Vdc*

This handle uses a printed circuit board that makes the step height and output current fully adjustable, accommodating high current applications. It also has pulse width modulation, that *dithers* the output to overcome hydraulic valve *stiction*. Full current output at 30 degrees handle stroke is a maximum of 2 Amps into a 5 Ohm load. Step current is a maximum 50% of full current output. Typical dither frequencies (dependent on resistance of the load, specified in the suffix number) are: 60 Hz for the HPI solenoid actuator, approximately 400 Hz for the V7058 Hydrotransmission Valve and approximately 1000 Hz for the MCV101A/ MCV116A Pressure Control Pilot Valve.

#### *M Proportional, three switches*

The three switches are: a wired center switch, one unwired switch in forward and one unwired switch in reverse.

---

There are either 3 or 4 trim potentiometers depending on the specific MCHXXX model. Reference *Handle Adjustments*, page 14.

---

#### **Connector**

##### *1 Terminal strip*

Electrical connections are made to a set of four internal or more screw terminals depending on the specific model.

##### *2 Pigtail 1524 mm [60 in] without connector*

Four wires extend from the handle case. Reference *Phasing and Color Scheme for Handle with Cable and Connector*, page 11 for lengths.

##### *3 Pigtail with unsealed Delphi connector*

The wires from the case terminate in a Delphi environmental connector. Reference *Phasing and Color Scheme for Handle with Cable and Connector*, page 11.

##### *6 Pigtail with sealed Delphi connector, 4 pin male and female*

There are two separate connectors, each connects to a separate potentiometer.

##### *7 Pigtail sealed Delphi connector*

The wires from the case terminate in a sealed Delphi connector.

##### *8 Pigtail sealed Deutsch connector*

The wires from the case terminate in a sealed Deutsch connector.

#### **Suffix number**

The factory generates these final three numbers. To create the suffix number, supply the following information: supply voltage, number of additional switches needed and actuation angle of each with respect to null, full current output, resistance of the driven load, and step current needed (if necessary).



**Dimensions**

*MCHXXX Control Handle Mounting Dimensions in mm [in]*

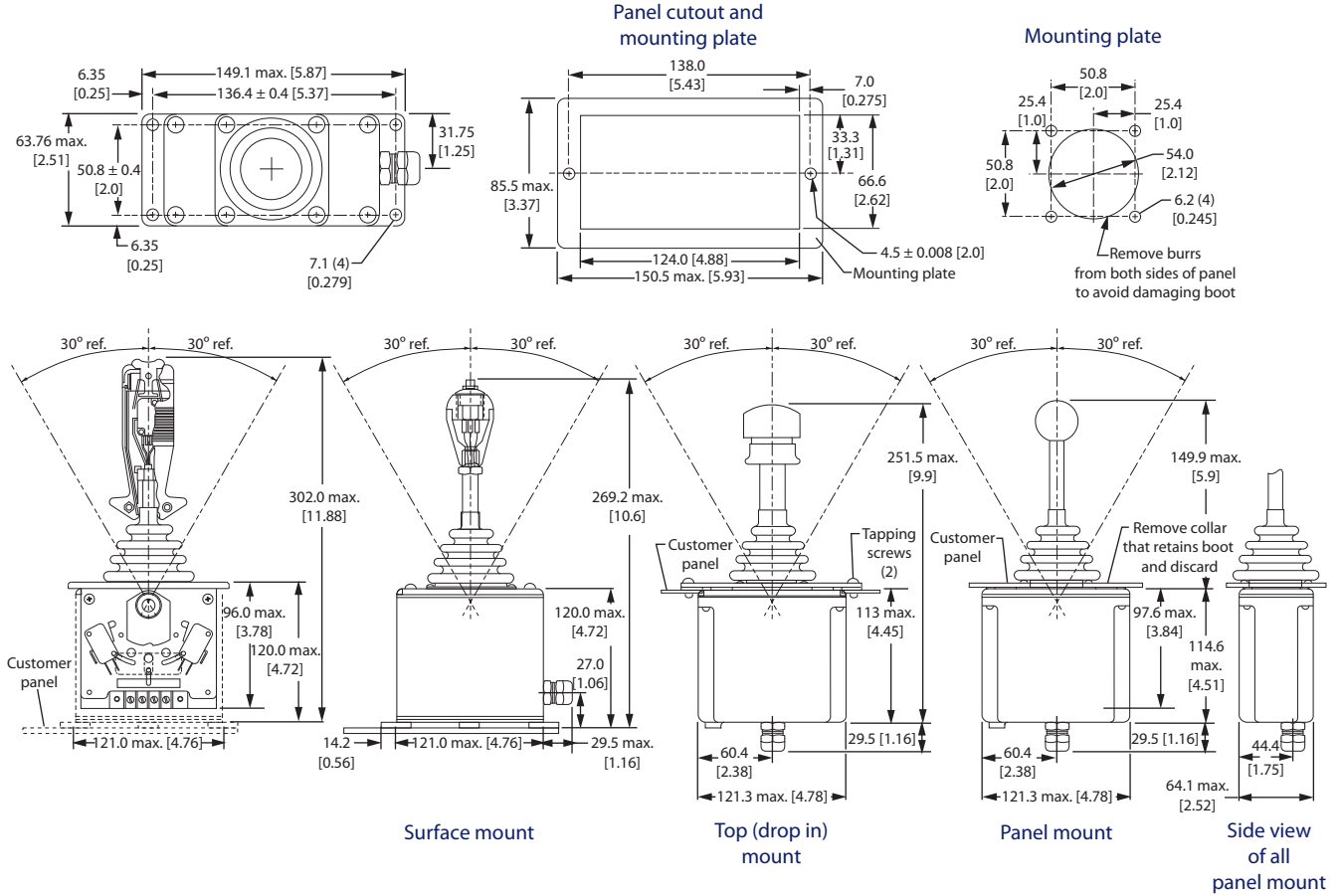

1135D

**Connectors**

3 or 4 pin Delphi Connector

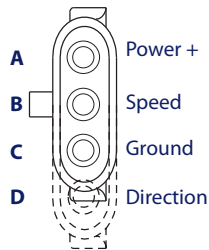

3524

4 pin Deutsch Plug DT Series Connector

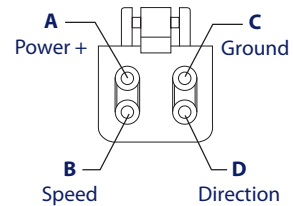

35

For optional connectors, contact your Sauer-Danfoss representative.

**Specifications**

*Electrical*

<b>Operating voltage</b>	11 to 15 Vdc (12 Volt models)
	22 to 30 Vdc (24 Volt models)
<b>Power*</b>	
<b>Load resistance*</b>	
<b>Switch current capability</b>	3 Amps inductive at 28 Vdc

\* Customer specified. Reference *Ordering Information*, page 5.

*Mechanical*

<b>Handle stroke</b>	$\pm 30^\circ$
<b>Spring torque</b>	1.2 $\pm$ .4 N·m [11 $\pm$ 4 lbf·in] at center breakaway
	2.0 $\pm$ .7 N·m [18 $\pm$ 6 lbf·in] at full stroke
<b>Detent torque (over and above friction drag)</b>	1.1 N·m [10 lbf·in]
<b>Friction drag</b>	1.5 $\pm$ .3 N·m [13.5 $\pm$ 3 lbf·in] Friction is adjusted at the brake with a 5/32 inch internal hex wrench and 3/8 inch open-end hex wrench

**PWM MCHXXX option**  
 will no longer be available  
 starting in 2008 as it nears  
 the end of its life cycle.

*Step-Plus-Proportional Control Handle  
 PWM Option*

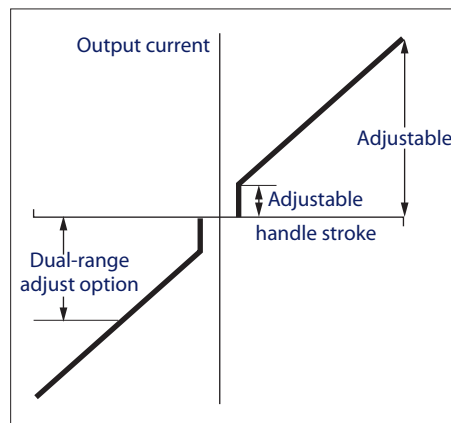

1140B

*Proportional Control Handle  
 Potentiometer Option*

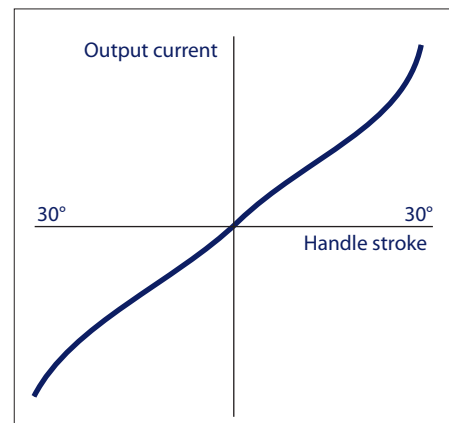

1139.

**Connection Diagrams**

**Potentiometer Option**

*Direct EDC Control*

---

Center-off switch assembly and wiring connections for the control handle.

---

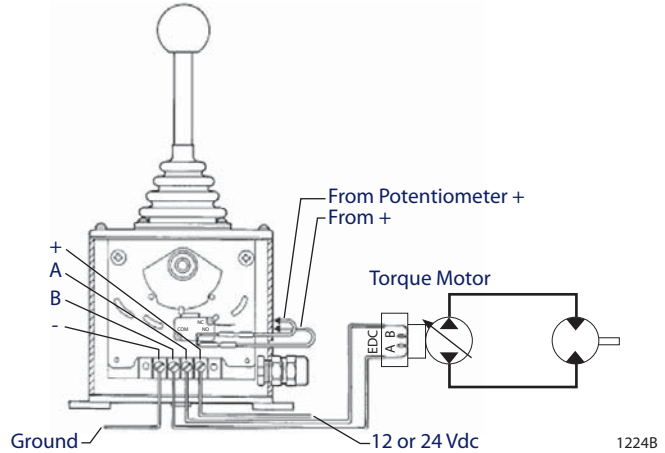

MCHXXX potentiometer models having either two or single 200 Ohm pots are configured to directly control Sauer-Danfoss variable pumps with electrical displacement controls (EDCs). Whether two or single pots, both require the same electrical connection to the EDC and only one of the dual coils needs to be connected to achieve forward and reverse pump flow.

Connection Diagrams  
 (continued)

Potentiometer Option with 1K Ohm Potentiometer  
 Analog Setpoint Controller Input

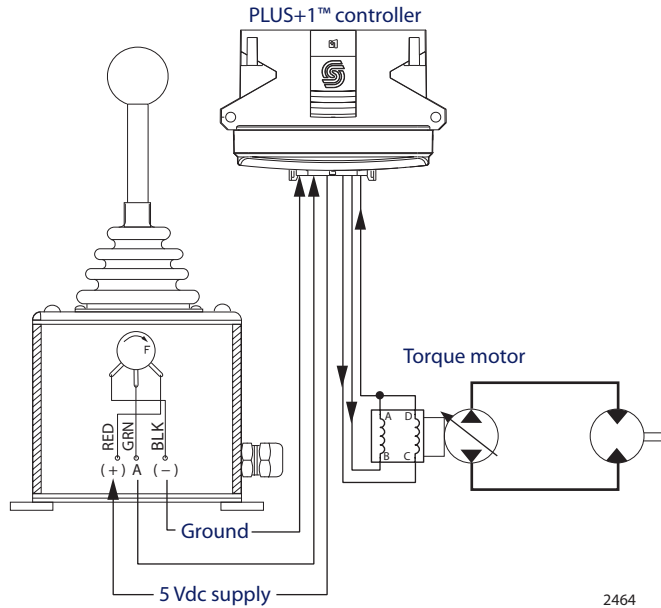

2464

MCHXXX potentiometer models having a 1K Ohm pot are commonly used as analog input to a controller (for example, SX or PLUS+1 MC200 Controllers). The supply voltage (5 Vdc sensor supply) is usually supplied from the controller.

MCHXXX Potentiometer Models with 1K Ohm

Material Number	Centerlock	Spring return	Friction hold	5 Vdc supply	Terminal strip	Microswitches		
						Forward	Neutral	Reverse
MCH11CB1510			X	X	X	X		
11046484 MCH12AR1642	X	X		X	X	X		X
10106017 MCH21CB1510			X	X	X	X		
11048497 MCH22AA1644	X	X		X	X			
11068164 MCH22BB1648	X		X	X	X		X	
MCH28BM1493 (No knob)			X	X	X		XX (2 switches)	X
MCH4FBD1505 (Operator presence)			X	X	X		X	X
MCH41BM1504			X	X	X	X	X	X
MCH43BD1499 (Push button)			X	X	X		X	X
MCH51AM1497		X		X	X	X	X	X
MCH51AR1509		X		X	X	X	X	X
11017769 MCH51BB1535			X	X	X		X	
MCH51BD1517			X	X	X		X	X
MCH52BM1497	X		X	X	X	X	X	X
MCH52BM1514	X		X	X	X	X	X	X
11090431 MCH19AM1649		X		X	X	X	X	X

**Connection Diagrams  
 (continued)**

**PWM MCHXXX option**  
 will no longer be available  
 starting in 2008 as it nears  
 the end of its life cycle.

**PWM Option (primarily)**

*Phasing and Color Scheme for Handle with Cable and Connector*

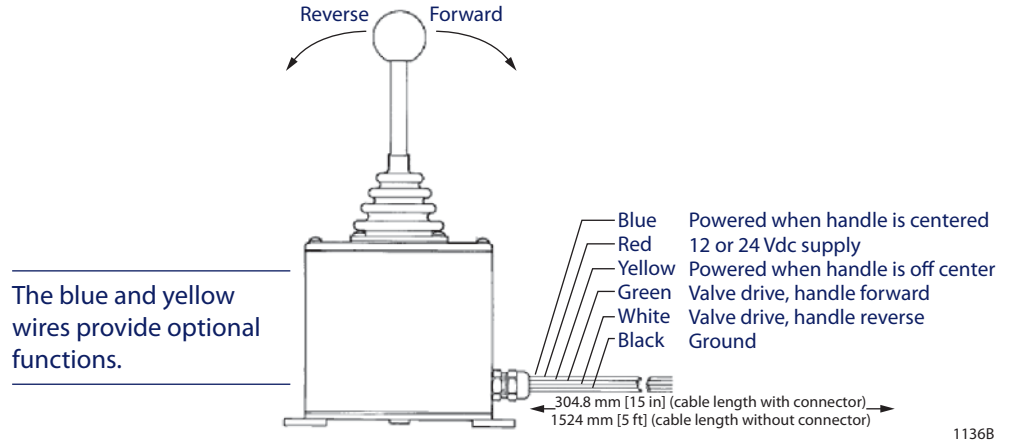

1136B

*Performance*

<b>Null current</b>	±5 mA maximum if not switched (12 Vdc models)
	±8 mA maximum if not switched (24 Vdc models)
<b>Center deadband (optional)</b>	±3° nominal
<b>Full stroke current capability*</b>	
<b>Step current*</b>	Step current occurs at end of deadband.

\* Customer specified. Reference *Ordering Information*, page 5.

**Environmental Testing**

<b>Temperature</b>	
Operating	-34° to 66°C [-30° to 150°F]
Storage	-40° to 77°C [-40° to 170°F]

<b>Humidity</b>
After being placed in a controlled atmosphere of 95% humidity at 38°C [100°F] for 10 days, the control handle performs normally.

<b>Rain</b>
After being showered from all directions by a high pressure hose, the control handle performs normally (applied to cased models only). This test fulfills NEMA 4 specifications (IP 65 equivalent).

<b>Vibration</b>
Withstands a vibration test designed for mobile equipment controls consisting of two parts: 1. Cycling from 5 to 2000 Hz in each of the 3 axes. 2. Resonance dwell for one million cycles for each resonance point in each of the 3 axes.

NEMA (National Electrical Manufacturer Association) NEMA 4 = Intended for indoor or outdoor use primarily to provide a degree of protection against windblown dust and rain, splashing water, hose-directed water and external ice formation.

**Wiring**

A barrier terminal strip inside the handle's case provides connections to power, ground, and potentiometers when no external cable is ordered. Run a cable from the strip through the strain relief provided on the side or bottom of the case. Reference *Center-Off Switch Assembly and Wiring Connections for the Control Handle*, page 11. A clockwise handle movement causes a current flow from terminal B to A when the terminal strip is facing you.

**▲ Warning**

An unforeseen failure may cause an output which could activate a valve or pump. If this occurs, the vehicle or mechanism may move, possibly endangering people or equipment. Equip handles with a center-off switch to mitigate this condition. For cases in which an active neutral is necessary, you must provide an operator-presence interlock and/or braking system sufficient to stop and hold the system or vehicle should this condition develop.

In most applications, auxiliary switches must be customer-wired, as shown in *Center-Off Switch Assembly and Wiring Connections for the Control Handle*, page 11. When the switch is used as a center-off, power is connected from the external 12 Volt supply to the terminal labeled *common*. The switch terminals are 3/16 inch quick-connect. *Phasing and Color Scheme for Handle with Cable and Connector*, page 11, shows a pre-wired control handle with center-off switch and Delphi connector, exhibiting the handle phasing and color coding of the wires.

The *Unsealed Delphi Mating Connector Assembly* below demonstrates how to assemble the mating Delphi connector (male shell, female sockets) used in *Phasing and Color Scheme for Handle with Cable and Connector*, page 11. The necessary parts are shipped in a bag assembly (part number K03370) composed of six sockets and one plastic connector body.

*Unsealed Delphi Mating Connector Assembly*

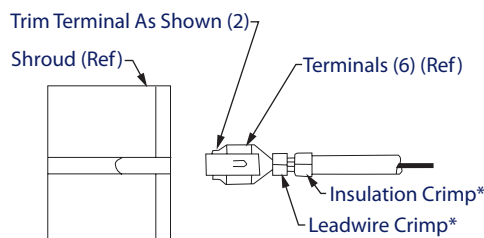

\* Crimp before inserting terminal into body

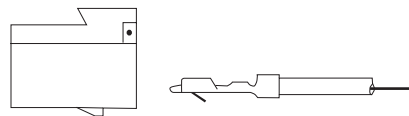

1137B

For optional connectors, contact your Sauer-Danfoss representative.

#### Wiring (continued)

**PWM MCHXXX option** will no longer be available starting in 2008 as it nears the end of its life cycle.

PWM MCHXXX option models are fitted with trim potentiometers for adjusting the output current. *MCHXXX PWM Option with Trim Potentiometer Configurations*, below shows the location of the three trim potentiometers on the L handle. There are either 3 or 4 trim potentiometers depending on the specific MCHXXX model. Reference *Electrical Characteristics, M Proportional, three switches*, page 8.

#### ⚠ Caution

Overcurrent could damage the control handle. Use a 1 Amp fuse in series for applications with low current requirements to avoid damaging the control handle.

*MCHXXX PWM Option with Trim Potentiometer Configurations*

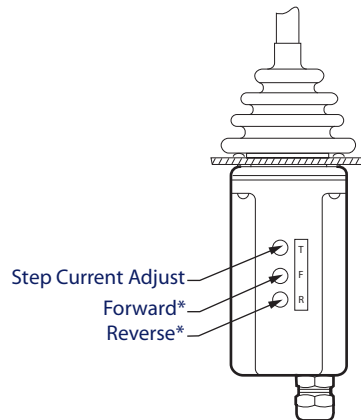

\* Span adjust or full current output

1138B

*Handle Adjustments*

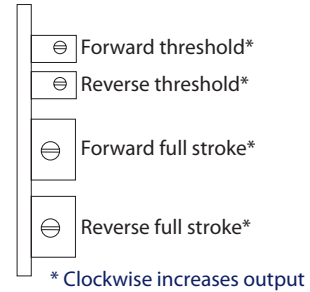

2382

**Option L** will no longer be available starting in 2008 as it nears the end of its life cycle.

#### L Control Handles

<b>Standard L</b>	Threshold adjustment Counter clockwise increases output	
	Forward full stroke Clockwise increases output	
	Reverse full stroke Clockwise increases output	
<b>L with (2) threshold adjustments</b>	Forward threshold Counter clockwise increases output	
	Reverse threshold Clockwise increases output	
	Forward full stroke Clockwise increases output	
	Reverse full stroke Clockwise increases output	
<b>L with acceleration/ deceleration Ramp</b>	Threshold adjustment Counter clockwise increases output	
	Forward full stroke Clockwise increases output	
	Reverse full stroke Clockwise increases output	
	Acceleration/deceleration ramp Clockwise increases time	

2383



MCHXXX Control Handle  
Technical Information  
Device Repair

**Return To**

Sauer-Danfoss  
Return Goods Department  
3500 Annapolis Lane North  
Minneapolis, Minnesota 55447

---

For devices in need of repair or evaluation, include a description of the problem and what work you believe needs to be done, along with your name, address and telephone number.

---





MCHXXX Control Handle  
Technical Information  
Notes



MCHXXX Control Handle  
Technical Information  
Notes



MCHXXX Control Handle  
Technical Information  
Notes



- Bent Axis Motors
- Closed Circuit Axial Piston Pumps and Motors
- Displays
- Electrohydraulic Power Steering
- Electrohydraulics
- Hydraulic Power Steering
- Integrated Systems
- Joysticks and Control Handles
- Microcontrollers and Software
- Open Circuit Axial Piston Pumps
- Orbital Motors
- PLUS+1™ GUIDE
- Proportional Valves
- Sensors
- Steering
- Transit Mixer Drives

## Members of the Sauer-Danfoss Group

### Comatrol

[www.comatrol.com](http://www.comatrol.com)

### Schwarz Müller-Inverter

[www.schwarzmueller-inverter.com](http://www.schwarzmueller-inverter.com)

### Turolla

[www.turollaocg.com](http://www.turollaocg.com)

### Hydro-Gear

[www.hydro-gear.com](http://www.hydro-gear.com)

### Sauer-Danfoss-Daikin

[www.sauer-danfoss-daikin.com](http://www.sauer-danfoss-daikin.com)

**Sauer-Danfoss** is a global manufacturer and supplier of high-quality hydraulic and electronic components. We specialize in providing state-of-the-art technology and solutions that excel in the harsh operating conditions of the mobile off-highway market. Building on our extensive applications expertise, we work closely with our customers to ensure exceptional performance for a broad range of off-highway vehicles.

We can help speed up system development, reduce costs and bring your vehicles to market faster. Sauer-Danfoss – Your Strongest Partner in Mobile Hydraulics.

**Go to [www.sauer-danfoss.com](http://www.sauer-danfoss.com) for further product information.**

Wherever off-highway vehicles are at work, so is Sauer-Danfoss.

We offer expert worldwide support for our customers, ensuring the best possible solutions for outstanding performance. And with an extensive network of Global Service Partners, we also provide comprehensive global service for all of our components.

Local address:

Sauer-Danfoss (US) Company  
2800 East 13th Street  
Ames, IA 50010, USA  
Phone: +1 515 239 6000  
Fax: +1 515 239 6618

Sauer-Danfoss ApS  
DK-6430 Nordborg, Denmark  
Phone: +45 7488 4444  
Fax: +45 7488 4400

Sauer-Danfoss GmbH & Co. OHG  
Postfach 2460, D-24531 Neumünster  
Krokamp 35, D-24539 Neumünster, Germany  
Phone: +49 4321 871 0  
Fax: +49 4321 871 122

Sauer-Danfoss-Daikin LTD.  
Shin-Osaka TERASAKI 3rd Bldg. 6F  
1-5-28 Nishimiyahara, Yodogawa-ku  
Osaka 532-0004, Japan  
Phone: +81 6 6395 6066  
Fax: +81 6 6395 8585